

**SINGLE NEEDLE CLOTH GUIDE ADJUSTABLE FEET**

G10-CRL

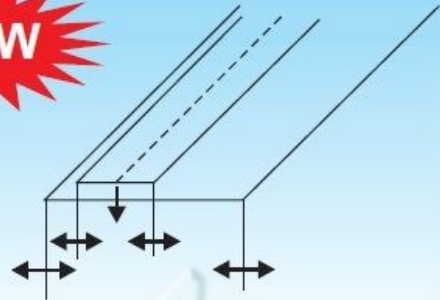

- 1. 可以調整左·右擋邊尺寸.
- 2. 車縫布條, 可調整大小, 0~20mm
- 1. CAN ADJUSTABLE THE SIZE OF BOTH SIDE ON THE EDGE.
- 2. SEAM CLOTH CAN ADJUSTABLE THE TAPE SIZE. 0~20mm

**ADJUSTABLE CONCEALED SEAM COMPENSATING FEET**

NR-31G



NL-31G

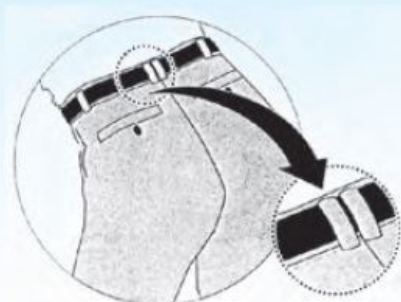
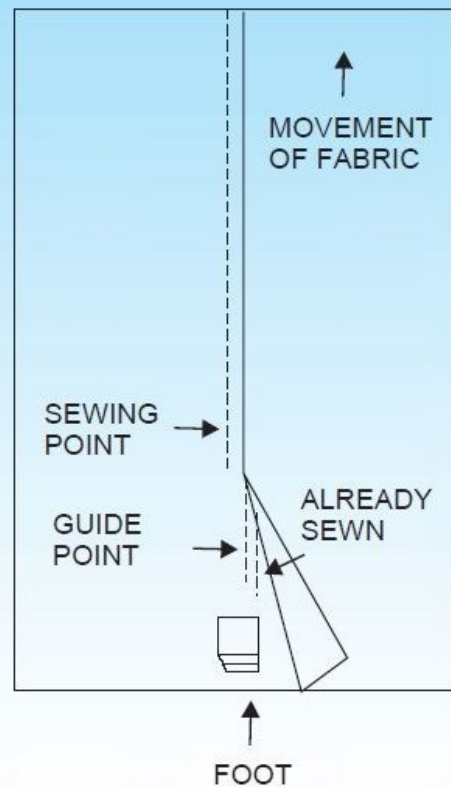

CONCEALED SEAM  
FOR SKIRTS OF SLACKS

## COMPENSATING FEET FOR KNIT



### CR1/16NK

CR1/32NK (210H)  
 CR1/16NK (211NH)  
 CR1/32K (21H)  
 CR1/16K (211H)  
 CR3/32K (2111/2H)  
 CR1/8K (212H)  
 CR5/32K (212 1/2H)  
 CR3/16K (213H)  
 CR1/4K (214H)  
 CR5/16K (215H)  
 CR3/8K (216H)  
 CR1/2K (218H)



### CL1/16NK

CL1/32NK (220H)  
 CL1/16NK (221NH)  
 CL1/32K (22H)  
 CL1/16K (221H)  
 CL3/32K (221 1/2H)  
 CL1/8K (222H)  
 CL5/32K (222 1/2H)  
 CL3/16K (223H)  
 CL1/4K (224H)  
 CL5/16K (225H)  
 CL3/8K (226H)  
 CL1/2K (228H)

## COMPENSATING FEET



### CR1/16N

CR1/32NN (210RN)  
 CR 1/16NN(211NN)  
 CR1/32N (210R)  
 CR1/16N (211N)  
 CR1/32E (21R)  
 CR1/16E (211R)  
 CR3/32E (2111/2)  
 CR1/8E (212R)  
 CR5/32E (212 1/2)  
 CR3/16E (213R)  
 CR1/4E (214R)  
 CR5/16E (215R)  
 CR3/8E (216R)  
 CR1/2E (218R)



### CL1/16N

CL1/32NN(220LN)  
 CL 1/16NN(221NN)  
 CL1/32N (220L)  
 CL1/16N (221N)  
 CL1/32E (22L)  
 CL1/16E (221L)  
 CL3/32E (221-1/2)  
 CL1/8E (222L)  
 CL5/32E (222 1/2)  
 CL3/16E (223L)  
 CL1/4E (224L)  
 CL5/16E (225L)  
 CL3/8E (226L)  
 CL1/2E (228L)

## COMPENSATING FEET FOR KNIT (STRENGTH)

USE ON THICKNESS OF FABRICS THE SIDE SCREW  
 CAN EASY HOLD THE GUIDE ,SO THE CLOTH CAN SMOOTHLY



### CR1/16NS

**NEW**

SIZE  
 CR1/32NS CR5/32ES  
 CR1/16NS CR3/16ES  
 CR1/32ES CR1/4ES  
 CR1/16ES CR5/16ES  
 CR3/32ES CR3/8ES  
 CR1/8ES CR1/2ES

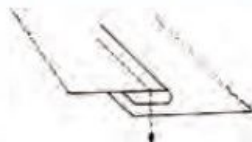

### CL1/16NS

**NEW**

SIZE  
 CL1/32NS CL5/32ES  
 CL1/16NS CL3/16ES  
 CL1/32ES CL1/4ES  
 CL1/16ES CL5/16ES  
 CL3/32ES CL3/8ES  
 CL1/8ES CL1/2ES

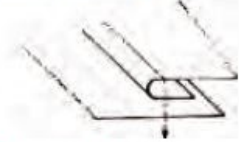

## COMPENSATING FEET



**CR15N**

- CR-10N-1.0mm
- CR-15N-1.5mm
- CR-10 -1.0mm
- CR-15 -1.5mm
- CR-20 -2.0mm
- CR-25 -2.5mm
- CR-30 -3.0mm
- CR-40 -4.0mm
- CR-50 -5.0mm
- CR-60 -6.0mm
- CR-65 -6.5mm
- CR-70 -7.0mm
- CR-80 -8.0mm
- CR-90 -9.0mm
- CR-100 -10 mm
- CR-110 -11 mm
- CR-130 -13 mm



**CL15N**

- CL-10N-1.0mm
- CL-15N-1.5mm
- CL-10 -1.0mm
- CL-15 -1.5mm
- CL-20 -2.0mm
- CL-25 -2.5mm
- CL-30 -3.0mm
- CL-40 -4.0mm
- CL-50 -5.0mm
- CL-60 -6.0mm
- CL-65 -6.5mm
- CL-70 -7.0mm
- CL-80 -8.0mm
- CL-90 -9.0mm
- CL-100 -10 mm
- CL-110 -11 mm
- CL-130 -13 mm

## COMPENSATING FEET(SHORT TOE)



**CR1/16**

- CR1/32
- CR1/16
- CR3/32
- CR1/8
- CR5/32
- CR3/16
- CR1/4
- CR5/16
- CR3/8
- CR1/2



**CL1/16**

- CL1/32
- CL1/16
- CL3/32
- CL1/8
- CL5/32
- CL3/16
- CL1/4
- CL5/16
- CL3/8
- CL1/2

## COMPENSATING FEET FOR KNIT (STRENGTH)

USE ON THICKNESS OF FABRICS THE SIDE SCREW CAN EASY HOLD THE GUIDE, SO THE CLOTH CAN SMOOTHLY (SHORT TOE)



- | SIZE (RIGHT) | SIZE (LEFT) |
|--------------|-------------|
| CR1/32S      | CL1/32S     |
| CR1/16S      | CL1/16S     |
| CR3/32S      | CL3/32S     |
| CR1/8S       | CL1/8S      |
| CR5/32S      | CL5/32S     |
| CR3/16S      | CL3/16S     |
| CR1/4S       | CL1/4S      |
| CR5/16S      | CL5/16S     |
| CR3/8S       | CL3/8S      |
| CR1/2S       | CL1/2S      |

## ADJUSTABLE PRESSET FOOT (EASY OPERATE DON'T STOP)

**P351KS**

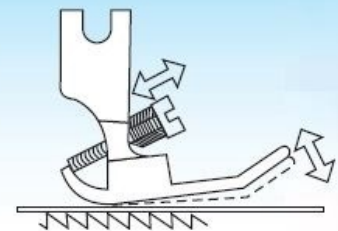

## COMPENSATING FEET(DOUBLE)



- CD3/16 DOUBLE**
- CDN-00 (230)
  - CD-00 (23)
  - CD-10 (1.0mm)
  - CD-15 (1.5mm)
  - CD-20 (2.0mm)
  - CDN-1/32(D23N)
  - CD-1/32 (D23)
  - CDN-1/16(D231N)
  - CD-1/16 (D231)
  - CD-1/8 (D232)
  - CD-3/16 (D233)
  - CD-1/4 (D234)

- 23-14-24 DOUBLE**
- 23-13-23 (1/32 -3/16-3/16)
  - 231-13-23 (1/16 -3/16-3/16)
  - 23-14-24 (1/32 -1/4-1/4)
  - 231-14-24 (1/16-1/4-1/4)
  - 23-15-25 (1/32-5/16-5/16)
  - 231-15-25 (1/16-5/16-5/16)
- 990474-0-01



## DUAL COMPENSATING FEET



- 211-16**
- 21-13 (1/32x3/16)
  - 211-13 (1/16x3/16)
  - 21-14 (1/32x1/4)
  - 211-14 (1/16x1/4)
  - 21-15 (1/32x5/16)
  - 211-15 (1/16x5/16)
  - 21-16 (1/32x3/8)
  - 211-16 (1/16x3/8)
  - 21-18 (1/32x1/2)
  - 211-18 (1/16x1/2)
- 990474-0-01



- 8-48**
- 8-32(1/32-1/8)
  - 8-48(1/32-3/16)
  - 8-64(1/32-1/4)
  - 8-80(1/32-5/16)
  - 16-32(1/16-1/8)
  - 16-48(1/16-3/16)
  - 16-64(1/16-1/4)
  - 16-80(1/16-5/16)

## PRESSER FOOT WITH GUIDE



- SP18-1/4**
- SP18-1/32
  - SP18-1/16
  - SP18-3/32
  - SP18-1/8
  - SP18-3/16
  - SP18-1/4
  - SP18-5/16
  - SP18-3/8



- SP18L-1/4**
- SP18L-1/32
  - SP18L-1/16
  - SP18L-3/32
  - SP18L-1/8
  - SP18L-3/16
  - SP18L-1/4
  - SP18L-5/16
  - SP18L-3/8

## COMPENSATING TEFLON FEET (LIGHT)



### RF1/16NK

RF1/32NK (PF210)  
 RF1/16NK (PF211N)  
 RF1/32K (PF21R)  
 RF1/16K (PF211R)  
 RF3/32K (PF2111/2)  
 RF1/8K (PF212R)  
 RF5/32K (PF212 1/2)  
 RF3/16K (PF213R)  
 RF1/4K (PF214R)  
 RF5/16K (PF215R)  
 RF3/8K (PF216R)  
 RF1/2K (PF218R)

薄物(LIGHT)



### LF1/16NK

LF1/32NK (PF220L)  
 LF1/16NK (PF221N)  
 LF1/32K (PF22L)  
 LF1/16K (PF221L)  
 LF3/32K (PF221 1/2)  
 LF1/8K (PF222L)  
 LF5/32K (PF222 1/2)  
 LF3/16K (PF223L)  
 LF1/4K (PF224L)  
 LF5/16K (PF225L)  
 LF3/8K (PF226L)  
 LF1/2K (PF228L)

薄物(LIGHT)

## COMPENSATING TEFLON FEET (REGULAR)



### RF1/16N

RF1/32N  
 RF1/16N  
 RF1/32  
 RF1/16  
 RF3/32  
 RF1/8  
 RF5/32  
 RF3/16  
 RF1/4  
 RF5/16  
 RF3/8  
 RF1/2



### LF1/16N

LF1/32N  
 LF1/16N  
 LF1/32  
 LF1/16  
 LF3/32  
 LF1/8  
 LF5/32  
 LF3/16  
 LF1/4  
 LF5/16  
 LF3/8  
 LF1/2

## COMPENSATING TEFLON FEET (REGULAR)



### RF15N

RF-10N-1.0mm  
 RF-15N-1.5mm  
 RF-10 -1.0mm  
 RF-15 -1.5mm  
 RF-20 -2.0mm  
 RF-25 -2.5mm  
 RF-30 -3.0mm  
 RF-40 -4.0mm  
 RF-50 -5.0mm  
 RF-60 -6.0mm  
 RF-65 -6.5mm  
 RF-70 -7.0mm  
 RF-80 -8.0mm  
 RF-90 -9.0mm  
 RF-100 -10 mm  
 RF-120 -12 mm  
 RF-130 -13 mm



### LF15N

LF-10N-1.0mm  
 LF-15N-1.5mm  
 LF-10 -1.0mm  
 LF-15 -1.5mm  
 LF-20 -2.0mm  
 LF-25 -2.5mm  
 LF-30 -3.0mm  
 LF-40 -4.0mm  
 LF-50 -5.0mm  
 LF-60 -6.0mm  
 LF-65 -6.5mm  
 LF-70 -7.0mm  
 LF-80 -8.0mm  
 LF-90 -9.0mm  
 LF-100 -10 mm  
 LF-120 -12 mm  
 LF-130 -13 mm

**TEFLON HINGED RASING FEET**

**CF811 RIGHT**



- CF810 -1/32
- CF811 -1/16
- CF8115-3/32
- CF812 -1/8
- CF813 -3/16
- CF814 -1/4
- CF815 -5/16
- CF816 -3/8
- CF818 -1/2

**CF811L LEFT**



- CF810L -1/32
- CF811L -1/16
- CF8115L- 3/32
- CF812L -1/8
- CF813L -3/16
- CF814L -1/4
- CF815L -5/16
- CF816L -3/8
- CF818L -1/2

**TEFLON FEET  
(LIGHT W/TAIL)**



- SIZE
- PF-231-HEAVY  
(CF-231-HEAVY)
  - PF-241-MEDIUM  
(CF-241-MEDIUM)
  - PF-251-LIGHT  
(CF-251-LIGHT)

**TEFLON FEET  
(LIGHT WITHOUT TAIL)**



- SIZE
- PF-131-HEAVY  
(CF-131-HEAVY)
  - PF-141-MEDIUM  
(CF-141-MEDIUM)
  - PF-151-LIGHT  
(CF-151-LIGHT)

**TEFLON FEET (LIGHT)**

**PFK161  
(CFK161)**



- SIZE
- PFK-161-LIGHTEST  
(CFK-161-LIGHTEST)
  - PFK-261-LIGHTEST W/TAIL  
(CFK-261-LIGHTEST W/TAIL)



SOLID THE CLOTH  
PROOF MOTION

**TEFLON FOOT  
(LINE ON THE CENTER EDGE GUIDE)**

**PF00  
(CF00)**



**TEFLON FEET (ZIPPER)**



SIZE	
CF36N	-4.6mm
CF363	-4.8mm
CF363V	-4.8mm
CF363VNF	-4.8mm
CF3CH	-4.8mm
CF3CSH	-4.8mm
CF36	-8mm
CF361	-8mm
CF36W	-10mm



SIZE	
CF36LN	-4.6mm
CF36L	-8mm
CF360	-8mm
CF58N	-8mm
CF36LW	-10mm
CF35	-11mm
CF351	-11mm
CF351W	-12.7mm

**TEFLON INVISIBLE FOOT**



**PF518N  
(CF518N)**



**PF518L  
(CF518L)**

**HINGED RASING FEET**



**P811 RIGHT**

P810	(12463H 1/32)
P811	(12463H 1/16)
P8115	(12463H 3/32)
P812	(12463H 1/8)
P813	(12463H 3/16)
P814	(12463H 1/4)
P815	(12463H 5/16)
P816	(12463H 3/8)
P818	(12463H 1/2)



**P811L LEFT**

P810L	(L12463H1/32)
P811L	(L12463H 1/16)
P8115L	(L12463H 3/32)
P812L	(L12463H1/8)
P813L	(L12463H3/16)
P814L	(L12463H1/4)
P815L	(L12463H5/16)
P816L	(L12463H3/8)
P818L	(L12463H1/2)

**HINGED PIPING FEET**



**P69RH-3/16 RIGHT**  
 P69RH1/16 (R36069H1/16)  
 P69RH1/8 (R36069H1/8)  
 P69RH3/16 (R36069H3/16)  
 P69RH1/4 (R36069H1/4)



**P69LH-3/16 LEFT**  
 P69LH1/16 (L36069H1/16)  
 P69LH1/8 (L36069H1/8)  
 P69LH3/16 (L36069H3/16)  
 P69LH1/4 (L36069H1/4)

**SPECIAL PIPING FEET**



**P31C1/4 RIGHT**  
 P31C1/8 (12435R 1/8)  
 P31C3/16 (12435R 3/16)  
 P31C1/4 (12435R 1/4)



**P301C1/4 LEFT**  
 P301C1/8 (31358L1/8)  
 P301C3/16 (31358L3/16)  
 P301C1/4 (31358L1/4)

**SPECIAL PIPING FEET**



**P69R3/8 RIGHT**  
 P69R1/16 (36069R 1/16)  
 P69R1/8 (36069R 1/8)  
 P69R3/16 (36069R 3/16)  
 P69R1/4 (36069R 1/4)  
 P69R3/8 (36069R 3/8)  
 P69R1/2 (36069R 1/2)  
 (26650R 1/8)



**P69L3/8 LEFT**  
 P69L1/16 (36069L 1/16)  
 P69L1/8 (36069L 1/8)  
 P69L3/16 (36069L 3/16)  
 P69L1/4 (36069L 1/4)  
 P69L3/8 (36069L 3/8)  
 P69L1/2 (36069L 1/2)  
 (26650L 1/8)



**DOUBLE PIPING FEET**



**P69D-1/4 (DOUBLE)**  
 P69D1/16 (36069DG 1/16)  
 P69D1/8 (36069DG 1/8)  
 P69D3/16 (36069DG 3/16)  
 P69D1/4 (36069DG 1/4)  
 (26650DG 1/8)

**BINDER FOOT**



**P37**  
 P39 -PLAIN  
 P37 -SMALLGROVE  
 P37M-MED. GROVE  
 P37W-LARGE GROVE

**BINDER FEET**



**A10-01**  
 (12142C)  
 A10-01- 3/4  
 A10-01-7/8  
 A10-01-1"  
 A10-01-1 1/8  
 A10-01-1 1/4  
 A10-01-1 3/8  
 A10-01-1 1/2

**BINDER FOOT (HINGED)**



**S70F 1/8**  
 S70F-1/16  
 S70F-1/8  
 S70F-3/16  
 S70F-1/4  
 S70F-5/16  
 S70F-3/8  
 S70F-1/2

**HEMMING & FOLDING FEET**

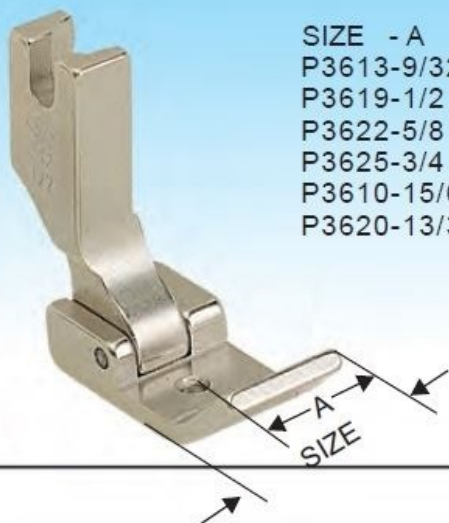

**SIZE - A**  
 P3613-9/32  
 P3619-1/2  
 P3622-5/8  
 P3625-3/4  
 P3610-15/64  
 P3620-13/32



**SIZE - A**  
 P3811 (S538-1/4)  
 P3819 (S539-1/2)  
 P3822 (5/8)  
 P3825 (S540-3/4)  
 (S541-1"5/16)

**HINGED BINDING FEET**

**NARROW**



RIGHT  
CHNR-1/32  
(KR-1-1/32)  
CHNR-1/16  
(KR-1-1/16)  
LEFT  
CHNL-1/32  
(KL-1-1/32)  
CHNL-1/16  
(KL-1-1/16)

**520-4**



**COMPENSATING BINDING FEET**



SIZE  
CB 3/4 (601)  
CB 1" (602)  
CB 1-1/8 (603)  
CB 1-1/4 (604)

**HEMMING & FOLDING FEET**

**S543(CHN)**



**S544(CHW)**



**12142AHB**



**SR-1**



**SOLID FOLDING FEET**

**P311  
(12143)**



**P33  
(12142)**



**P34**



**P344**



**BINDING FOOT**

**P983**  
(25983)



**S545**  
(P38)



**SHIRRING FEET**

**P50**

SIZE

P50N (120828N)  
P50 (120828)  
P50M (120828M)  
P50H (120828H)



**3 SCROLL HEMMER FT**

**2 1/2**



SIZE

1	(160344-1/16)
1 1/2	(120802-1 1/2)
2	(120938-3/32)
2 1/2	(120803-1/8)
02	(1/8)
3	(120804-5/32)
4	(120805-3/16)
04	(3/16)
5	(120940-7/32)
6	(120806-1/4)
06	(1/4)

**ELASTING SHIRRING FEET**

**A227**

SIZE

A227-1/8	(S537-1/8)
A227-3/16	(S537-3/16)
A227-1/4	(S537-1/4)
A227-5/16	(S537-5/16)
A227-3/8	(S537-3/8)
A227-1/2	(S537-1/2)



**BINDER FEET**

**S532(P312SB)**



**ADJUSTABLE TAPE FEET**

**S534(A225)**



5~50mm

## HINGED TUBE FEET

**S10C-1/2**

SIZE(CENTER)

S10C-1/8 (P318C 1/8)  
S10C-3/16 (P3316C 3/16)  
S10C-1/4 (P314C 1/4)  
S10C-5/16 (P3516C 5/16)  
S10C-3/8 (P338C 3/8)  
S10C-1/2 (P312C 1/2)  
S10C-5/8 (P358C 5/8)  
S10C-3/4 (P334C 3/4)  
S10C-1" (P325C1")



**S10R-1/2**

SIZE(RIGHT)

S10R-1/8 (P318R 1/8)  
S10R-3/16 (P3316R 3/16)  
S10R-1/4 (P314R 1/4)  
S10R-5/16 (P3516R 5/16)  
S10R-3/8 (P338R 3/8)  
S10R-1/2 (P312R 1/2)  
S10R-5/8 (P358R 5/8)  
S10R-3/4 (P334R 3/4)  
S10R-1" (P325R1")



## HINGED TUBE FEET

**S10L-1/2**

SIZE(LEFT)

S10L-1/8 (P318L1/8)  
S10L-3/16 (P3316L3/16)  
S10L-1/4 (P314L1/4)  
S10L-5/16 (P3516L5/16)  
S10L-3/8 (P338L3/8)  
S10L-1/2 (P312L1/2)  
S10L-5/8 (P358L5/8)  
S10L-3/4 (P334L3/4)  
S10L-1" (P325L1")



## TOP STITCH FEET

**P14**

SIZE

P10 (36465-1/32)  
P11 (36465-1/16)  
P115 (36465-3/32)  
P12 (36465-1/8)  
P13 (36465-3/16)  
P14 (36465-1/4)  
P15 (36465-5/16)  
P16 (36465-3/8)  
P18 (36465-1/2)  
P01 (36464N)(P10~P14)  
P01W (36464W)(P15~18)



## SHIRRING FEET

**S952(P952)**



**S950(P950)**



**P5R**



**P5W**



**SOLID ZIPPER FEET**

S530S



S531L



P3  
(165010)



P3C  
(40322)



**SOLID ZIPPER FEET**

P3CS  
(40322CS)



P311N  
(12435N)



P301N  
(31358N)



P31  
(12435W)



**ZIPPER FEET**

P301  
(31358W)



P363V  
(165010H)



P363  
(40322SH)



P36N  
(12435HN)



**HINGED ZIPPER FEET** **SOLID CONCEALED ZIPPER FEET (PLASTIC)**

<p><b>P36</b> (12435HW)</p> 	<p><b>P36W</b> (12435HXW)</p> 	<p><b>D36NH</b> DOUBLE</p>  <p><b>NEW</b></p>	<p><b>2CJ1(尖)</b> (NP-63P-2)</p>  <p>WHITE/WITH FRONT GUIDE</p>
---	---	---	--

**HINGED ZIPPER FEET** **SOLID CONCEALED ZIPPER FEET (PLASTIC)**

<p><b>P36LN</b> (31358HN)</p> 	<p><b>P36L</b> (31358HW)</p> 	<p><b>D36H</b> DOUBLE</p>  <p><b>NEW</b></p>	<p><b>3CJ1(平)</b> (NP-63P-1)</p>  <p>GREEN</p>
---	--	--	---

**HINGED ZIPPER FEET** **ZIPPER FOOT**

<p><b>P36LW</b> (31358HXW)</p> 	<p><b>P360</b> (121947H)</p> 	<p><b>P361</b> (121905H)</p> 	<p><b>S510</b> ENTER GUIDE FOOT</p> 
--	--	---	---

**HINGED INVISIBLE ZIPPER FEET**

S518L



S518N-G  
S518N



S518NE



S518 **SIZE**  
S518-2.0mm  
S518H-2.5mm



**INVISIBLE ZIPPER FEET**

S518S



S518A



**ZIPPER FEET**

P946  
(121946)



P58N  
(142058N)



P58W  
(142058W)



P144H  
(12144H)



**SIZE**  
P144H  
(12144H)  
P144HL  
(12144HLD)  
P144HLB  
(12144HLB)

P35  
(24983)



P35K  
(24983K)



LIGHT (薄物用)

**HINGED STANDARD FOOT**

P351 (52427)



P352



P351K



LIGHT  
(薄物用)

P193  
(19336)



**QUILTER & GUIDE FEET**

S524  
7/32"~1"



P81  
(S523)  
1/32"~3/4"



P801  
1/32"~3/4"



P803  
3/16"~7/8"



**QUILTER & GUIDE FEET**

P723  
(S521)  
3/16"~2"



**HINGE FOOT**

113280  
(113280-0-01)



150384-0-01

150789  
(150789-0-01)





FOOT FOR COLLARS & BACK BINDINGS SOLID BLANK FOOT		SOLID BLANK FEET			
147308(ART.570) 	SP-44 	SP-60 (S402) 	SP-61 (S801) 		
SOLID BLANK FEET					
SP-62 (S802) 	SP-63 (S803) 	SP-64 (S804) 	SP-65 (S400) 		
STANDARD FEET	QUILTER FEET	HINGED PRESSER FEET (HEAVY W/GUARD)	HINGED PRESSER FEET		
P127 (127233)  厚物用HEAVY	160342 	B1511 -543-BBA  D-1421-555 -DOO	B1524 -522-NBO-A  SIZE 1/8		
		特厚物用 MORE HEAVY			

**STANDARD HINGED FEET**

B1524-012-OAO



B1524-012-BBA



B1524-012-OBO



51742-G  
51742  
(91-051742-03)



**SIZE**  
1.8mm  
2.2mm

**NYLON RING FOOT**

S515  
(CF2-S)



SR-DB-W  
(TRF-1)



**NYLON RING FOOT**

SR-DB-R



SR-DB-L



**ROLLER PRESSER FOOT**

SDRF



**ROLLER FEET**

SPK-3



**ROLLER FEET WITH GUIDE**



(RIGHT)  
SIZE  
R-810 1/32  
R-811 1/16  
R-812 1/8  
R-813 3/16  
R-814 1/4  
R-815 5/16

**NEW**



(LEFT)  
SIZE  
R-810L 1/32  
R-811L 1/16  
R-812L 1/8  
R-813L 3/16  
R-814L 1/4  
R-815L 5/16

**NEW**

**ROLLER FEET**

R2E



**ROLLER FEET  
(SPECIAL)**

R-3



**NEW**

SIZE  
R-1 LIGHT  
(HM1-1)  
R-2 MEDIUM  
(HM1-2)  
R-3 HEAVY  
(HM1-3)

## ROLLER FEET (SPECIAL)



## ROLLER COMPENSATING FEET (SPECIAL)



## ROLLER FOOT

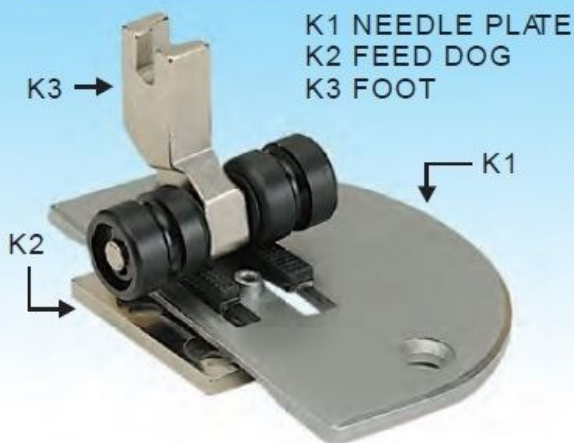

## CHAIN CUT-OFF FEET



**DOMESTIC HEMMER FEET**

**H15SH**  
(2858)

SIZE  
2.0mm  
2.5mm  
3.0mm  
4.0mm



**DOMESTIC PIPING FEET**

**H15-69HL**

SIZE  
1/8 -3.2mm  
3/16 -4.8mm  
1/4 -6.4mm



**DOMESTIC Z-Z FEET**

**H15Z**



**COMPENSATING FEET FOR DOMESTIC MACHINES**

**H15**

SIZE  
H10-1.0MM  
H15-1.5MM (ART.1926/1)  
H20-2.0MM  
H25-2.5MM (ART.1926/2)  
H30-3.0MM (ART.1926/3)  
H40-4.0MM (ART.1926/4)  
H50-5.0MM (ART.1926/5)  
H60-6.0MM (ART.1926/6)



**Z/Z DOUBLE COMPENSATING FEET**

**H15ZZ**  
(ART. 1929)

SIZE  
3.0MM  
6.0MM



**UNION SPECIAL COMPENSATING FEET**

SIZE  
US31 -1/32  
US311 -1/16  
US312 -1/8  
US313 -3/16  
US314 - 1/4



**UNION SPECIAL HINGED FEET**

SIZE  
61220J  
61220P  
61320J  
US12435HN  
US12435HW  
US31358HN  
US31358HW  
US40322SH



## MANUL INVISIBLE BLADE FOOT (CUTTER THREAD)

YS-37 (NP-37)

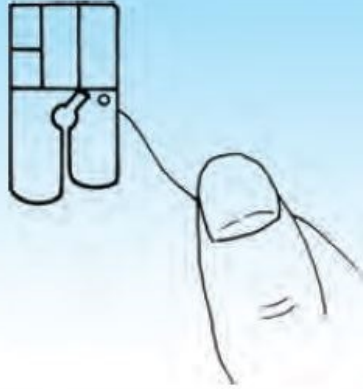
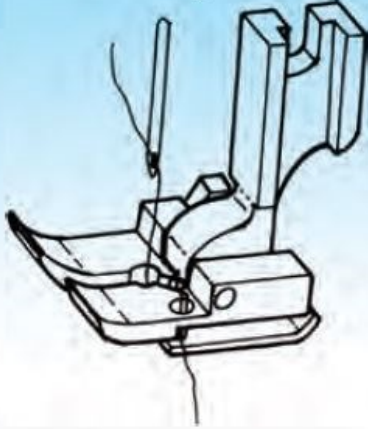

## SPECIAL DESIGN FOOT (CUTTER THREAD)

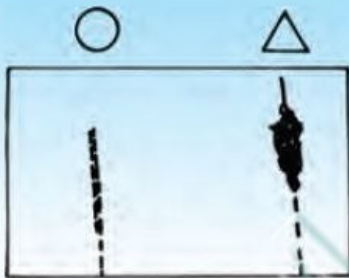

(W/TAILO)  
368611



(W/O TAIL)  
368607



## TEFLON COMPENSATING FOOT

SIZE(RIGHT)



TCR1/32N(MT210)-B  
TCR1/16N(MT211N)-B  
TCR1/32 (MT21R)-B  
TCR1/16 (MT211)-B  
TCR3/32 (MT2111/2)-B  
TCR1/8 (MT212)-B  
TCR3/16 (MT213)-B  
TCR1/4 (MT214)-B  
TCR5/16 (MT215)-B  
TCR3/8 (MT216)-B  
TCR1/2 (MT218)-B

SIZE(LEFT)



TCL1/32N (MT-220)-B  
TCL1/16N (MT-221N)-B  
TCL1/32 (MT22)-B  
TCL1/16 (MT221)-B  
TCL3/32 (MT221 1/2)-B  
TCL1/8 (MT222)-B  
TCL3/16 (MT223)-B  
TCL1/4 (MT224)-B  
TCL5/16 (MT225)-B  
TCL3/8 (MT226)-B  
TCL1/2 (MT228)-B

**TEFLON FOOT**



**TEFLON FOOT**



**TEFLON FOOT**



## QUILTER & GUIDE FEET

P35G

**NEW**



可以調整左-右擋邊尺寸  
CAN ADJUSTABLE THE SIZE OF BOTH SIDE ON THE EGDE

## TEFLON FEET

NT-18

NT-18B



**HINGED FEET  
FOR NEEDLE FEED  
MACHINE**

**(SINGLE NEEDLE)**

PAFF 461 ; 481  
DURKOPP CL.272  
JUKI DLM-522 ALL USED  
(PAGE 24-29)

## NEEDLE FEED COMPENSATING FOOT PFAFFCL.461,481 DURKOPP CL.272

### SIZE(RIGHT)

- 210- NF(NARROW-1/32)
- 211N- NF(NARROW-1/16)
- 21R- NF(ART.1649/2-1/32)
- 211- NF(ART.1649/4-1/16)
- 20R- NF(5/64)
- 25R- NF(3/32)
- 212- NF(ART.1649/6-1/8)
- 213- NF(ART.1649/8-3/16)
- 214- NF(ART.1649/10-1/4)
- 215- NF(ART.1649/12-5/16)
- 216- NF(ART.1649/14-3/8)
- 218- NF(ART.1649/16-1/2)



### SIZE(LEFT)

- 220- NF(NARROW-1/32)
- 221N- NF(NARROW-1/16)
- 22L- NF(ART.1649/1-1/32)
- 221- NF(ART.1649/3-1/16)
- 20L- NF(5/64)
- 25L- NF(3/32)
- 222- NF(ART.1649/5-1/8)
- 223- NF(ART.1649/7-3/16)
- 224- NF(ART.1649/9-1/4)
- 225- NF(ART.1649/11-5/16)
- 226- NF(ART.1649/13-3/8)
- 228- NF(ART.1649/15-1/2)



## COMPENSATING FEET FOR KNIT

**USE ON THICKNESS OF FABRICS THE SIDE SCREW  
CAN EASY HOLD THE GUIDE ,SO THE CLOTH CAN SMOOTHLY**

### SIZE(STRENGTH)

- 210S- NF(NARROW-1/32)
- 211NS- NF(NARROW-1/16)
- 21RS- NF(ART.1649/2-1/32)
- 211S- NF(ART.1649/4-1/16)
- 20RS- NF(5/64)
- 25RS- NF(3/32)
- 212S- NF(ART.1649/6-1/8)
- 213S- NF(ART.1649/8-3/16)
- 214S- NF(ART.1649/10-1/4)
- 215S- NF(ART.1649/12-5/16)
- 216S- NF(ART.1649/14-3/8)
- 218S- NF(ART.1649/16-1/2)



### SIZE(STRENGTH)

- 220S- NF(NARROW-1/32)
- 221NS- NF(NARROW-1/16)
- 22LS- NF(ART.1649/1-1/32)
- 221S- NF(ART.1649/3-1/16)
- 20LS- NF(5/64)
- 25LS- NF(3/32)
- 222S- NF(ART.1649/5-1/8)
- 223S- NF(ART.1649/7-3/16)
- 224S- NF(ART.1649/9-1/4)
- 225S- NF(ART.1649/11-5/16)
- 226S- NF(ART.1649/13-3/8)
- 228S- NF(ART.1649/15-1/2)





## NEEDLE FEED W/GUIDE HINGED FEET



SIZE(RIGHT)  
 SP18-NF 1/32 = 1.0mm  
 SP18-NF 1/16 = 1.6mm  
 SP18-NF 3/32 = 2.4mm  
 SP18-NF 1/8 = 3.2mm  
 SP18-NF 3/16 = 4.8mm  
 SP18-NF 1/4 = 6.4mm  
 SP18-NF 5/16 = 8.0mm  
 SP18-NF 3/8 = 9.6mm

**NEW**



SIZE(LEFT)  
 SP18L-NF 1/32=1.0mm  
 SP18L-NF 1/16=1.6mm  
 SP18L-NF 3/32=2.4mm  
 SP18L-NF 1/8 =3.2mm  
 SP18L-NF 3/16=4.8mm  
 SP18L-NF 1/4 =6.4mm  
 SP18L-NF 5/16=8.0mm  
 SP18L-NF 3/8 =9.6mm

**NEW**

## NEEDLE FEED W/GUIDE HINGED FEET



SIZE(RIGHT)  
 P810-NF 1/32 = 1.0mm  
 P811-NF 1/16 = 1.6mm  
 P812-NF 1/8 = 3.2mm  
 P813-NF 3/16 = 4.8mm  
 P814-NF 1/4 = 6.4mm  
 P815-NF 5/16 = 8.0mm  
 P816-NF 3/8 = 9.6mm

**NEW**



SIZE(LEFT)  
 P820-NF 1/32 = 1.0mm  
 P821-NF 1/16 = 1.6mm  
 P822-NF 1/8 = 3.2mm  
 P823-NF 3/16 = 4.8mm  
 P824-NF 1/4 = 6.4mm  
 P825-NF 5/16 = 8.0mm  
 P826-NF 3/8 = 9.6mm

**NEW**

## NEEDLE FEED PIPING HINGED FEET



SIZE(RIGHT)  
 P69RH-NF 1/8  
 P69RH-NF 3/16  
 P69RH-NF 1/4  
 P69RH-NF 5/16

**NEW**



SIZE(LEFT)  
 P69LH-NF 1/8  
 P69LH-NF 3/16  
 P69LH-NF 1/4  
 P69LH-NF 5/16

**NEW**

**NEEDLE FEED ADJUSTABLE W/GUIDE FEET**

G10-NF



- 1. 可以調整左·右擋邊尺寸.
- 2. 車縫布條·可調整大小·0~20mm
- 1. CAN ADJUSTABLE THE SIZE OF BOTH SIDE ON THE EDGE.
- 2. SEAM CLOTH CAN ADJUSTABLE THE TAPE SIZE. 0~20mm

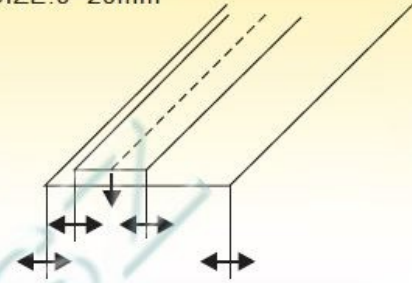

**NEEDLE FEED ADJUSTABLE W/GUIDE FEET**

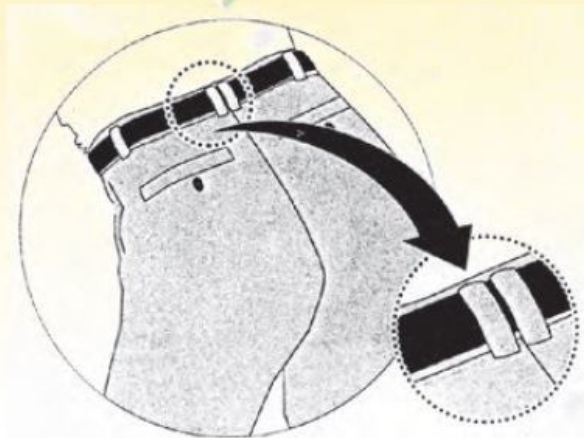

NR31G-NF

NL31G-NF

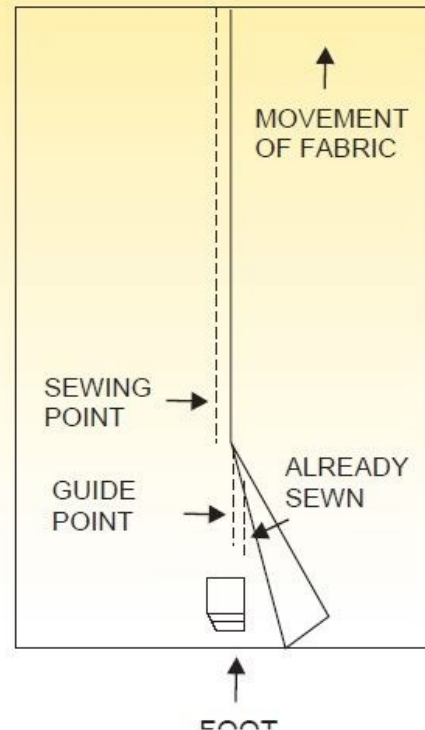

CONCEALED SEAM FOR SKIRTS OF SLACKS



NEEDLE FEED ZIPPER FEET	NEEDLE FEED ROLLER FEET	NEEDLE FEED W/QULTER GUIDE
<p>P35G-NF <b>NEW</b></p>  <p>可以調整左、右擋邊尺寸。 CAN ADJUSTABLE THE SIZE OF BOTH SIDE ON THE EGDE.</p>	<p>R-351-NF</p> 	<p>P723-NF</p>  <p>5~50mm</p>

NEEDLE FEED ZIPPER FEET			
<p>P363-NF(S363-NF) (ART.1680)</p> <p>SIZE P363-NF 5.4mm</p> <p>P363W-NF 7.0mm (ART.1688)</p>  <p>5.4mm</p>	<p>P36N-NF(S5000N) (ART.1684)</p>  <p>5.0mm</p>	<p>P36-NF(S8000N) (ART.1690)</p>  <p>8.0mm</p>	<p>P361-NF (S6020N)</p>  <p>8.0mm</p>

NEEDLE FEED ZIPPER FEET			
<p>P351N-NF <b>NEW</b></p>  <p>9mm</p>	<p>P36LN-NF(S0050N) (ART.1683)</p>  <p>5.0mm</p>	<p>P36L-NF(S0080) (ART.1689)</p>  <p>8.0mm</p>	<p>P360-NF(S2060N)</p>  <p>8.0mm</p>

**NEEDLE FEED FEET**

<p>P351-NF (S351NF)</p>  <p>11mm</p>	<p>P127-NF (ART.6643)</p>  <p>12mm</p>	<p>P127WK-NF</p>  <p>LIGHT 薄物用</p> <p>14mm</p>	<p>P127W-NF (ART.6644)</p>  <p>14mm</p>
---	---	--	--

**NEEDLE FEED FEET**

<p>S518N-NF (ART.1526/1)</p> 	<p>P363VNF</p>  <p>5.0mm</p>	<p>P27 (S5050N) (149027) (149085)</p> 	<p>12142AHBNF</p> 
---	---	--	--

**NEEDLE FEED FEET**

<p>B1524-041-EAO</p> 	<p>B1524-412-OAO</p> 	<p>B1524-412-OBO (410916)</p> 	<p>B1524-415-BBA</p> 
--	--	--	--

## NEEDLE FEED FEET PFAFF CL.461;481 DURKOPPCL.272 JUKIDLM-522

**P36D-NF**  
(ART.6648)  
DOUBLE



7mm

**S518-NF**  
(ART.1525/1)



**140717-NF**  
(140717-0-01)  
(503541)



**MT1-NF**  
(ART.1602)



MT1-NFB →

## NEED FEED ADJUSTABLE CLOTH GUIDE FOR NECCHI CL.881

**NH-10G**



1. 可以調整左、右擋邊尺寸。
2. 車縫布條。可調整大小0~20mm.
1. CAN ADJUSTABLE THE SIZE OF BOTH SIDE ON THE EDGE.
2. SEAM CLOTH CAN ADJUSTABLE THE TAPE SIZE. 0~20mm

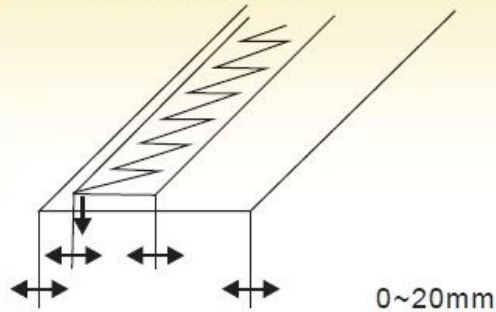

0~20mm

## COMPENSATORE FOOT FOR NECCHI CL.881

(LEFT)  
NH8820 (ART.1626/1-1/32)  
NH8821 (ART.1626/3-1/16)  
NH8821N-1/16(NARROW)



(RIGHT)  
NH8810 (ART.1626/2-1/32)  
NH8811 (ART.1626/4-1/16)  
NH8811N-1/16(NARROW)  
NH8812 (ART.1626/5-1/8)  
NH8813 (ART.1626/6-3/16)  
NH8814 (ART.1626/7-1/4)  
NH8815 (ART.1626/8-5/16)  
Nh8816 (ART.1626/9-3/8)

**NH36LN**(ART.1647)



5.4mm

**PRESSER FEET FOR NECCHI CL.881**

**NH36N**  
(ART.1648)



5.4mm

**NH363**  
(ART.1646)



5.4mm

**NH35**  
(ART.1551)  
(961789-3-00)



11mm

**NH351**



11mm

**PRESSER FEET FOR NECCHI CL.881**

**NH351W**  
(ART.1522)  
(961761-3-00)



12.7mm

**NH127**



13mm

**NH127W**



14mm

**THE PRODUCTS  
INTRODUCE  
AS BELOW**



ZIG-ZAG HINGED FOOT  
BROTHER 651.652  
SINGER 20U  
PFAFF 483etc.

**Z-Z MACHINE ADJUSTABLE CLOTH GUIDE FEET**

**G10-652**



1. 可以調整左·右擋邊尺寸。
2. 車縫布條·可調整大小· 0~20mm
1. CAN ADJUSTABLE THE SIZE OF BOTH SIDE ON THE EGDE.
2. SEAM CLOTH CANADJUSTABLE THE TAPE SIZE. 0~20mm

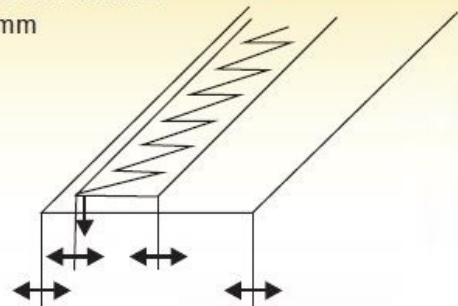

Z-Z ROLLER FEET		Z-Z HEMMER FEET		ZIG-ZAG FEET			
<p>R-652</p>  <p>SIZE 6mm 12mm</p>		<p>652SH</p>  <p>SIZE 3mm 5mm</p>		<p>652-35 (ART.1468)</p>  <p>3mm</p>		<p>55112B-G (91-055112)</p>  <p>4.5mm</p>	
ZIG-ZAG FEET			ZIG-ZAG COMPENSATING FEET				
<p>54501 54501-G (91-054501-03C)</p>  <p>1/4(6.4mm)</p>		<p>230ZZ</p>  <p>SIZE 3mm (ART.1629/3) 5mm (ART.1629/5)</p>		<p>652RZ (ART.1699)</p> 		<p>652LZ (ART.1699/1)</p> 	
ZIG-ZAG FOOT							
<p>55106 55106-G (91-055106CX-10)</p>  <p>10mm</p>		<p>541566</p>  <p>10mm</p>		<p>541781</p>  <p>10mm</p>		<p>543939</p>  <p>12mm</p>	

## ZIG-ZAG FOOT

<p>MT541566</p>  <p>SIZE 5mm 12mm</p> <p>MT541566B </p>	<p>112800-0-01</p>  <p>5mm</p>	<p>111994-0-01</p>  <p>12mm</p>	<p>說明如下 <b>ACCOUNT AS BELOW</b></p> 
---	---	---	---

## PFAFF MACHINE ADJUSTABLE CLOTH GUIDE PFAFF CL.141.138.238

PF10G



**NEW**

1. 可以調整左-右擋邊尺寸.  
2. 車縫布條. 可調整大小. 0~20mm

1. CAN ADJUSTABLE THE SIZE OF BOTH SIDE ON THE EDGE.  
2. SEAM CLOTH CAN ADJUSTABLE THE TAPE SIZE. 0~20mm



## PFAFF FEET CL.141;138;238

<p><b>611P</b> SIZE(RIGHT) 610NP1/32 (NARROW) 611NP1/16 (NARROW) 611P1/16 612P1/8 613P3/16 614P1/4</p> 	<p><b>621P</b> SIZE(LEFT) 620NP1/32 (NARROW) 621P1/16</p> 	<p><b>630P</b> (DOUBLE) SIZE 630P1/32 631P1/16</p> 	<p><b>630ZZ</b> (91-0511863-93)</p>  <p>SIZE 3mm 5mm</p>
--	---	---	---



## PPAFF FEET CL.141;138;238

26473  
(91-026473-05)



26474  
(91-026474-05)



46682  
(91-046682-03)



43522A  
(91-043522-03)



## PRESSER FEET FOR PPAFF CL142;1242;921;925

54926-1/4



SIZE  
54926-3/16  
(91-054926-03)  
54926-1/4  
(91-054926-03)  
54926-9/32  
(91-054926-03)

PF248



SIZE  
PF248  
30715-3-00mm4.8  
PF260  
961044-3-00mm6.0  
PF264  
961044-3-10mm6.4

PFG248



SIZE  
PFG248(1.0mm)  
(ART.1651/1-mm4.8-1.0mm)  
PFG248(2.0mm)  
(ART.1651/1-mm4.8-2.0mm)  
PFG264(1.0mm)  
(ART.1651/2-mm6.4-1.0mm)  
PFG264(2.0mm)  
(ART.1651/2-mm6.4-2.0mm)

PFR248



SIZE  
PFR248  
(ART.1628/1-mm4.8)  
PFR264  
(ART.1628/2-mm6.4)

## PRESSER FEET FOR PPAFF CL.142;1242;921;925

PFD248



SIZE  
PFD248  
(ART.1639/1-mm4.8)  
PFD264  
(ART.1639/2-mm6.4)

## COPENSATING FEET FOR NECCHI CL.831



(LEFT)  
NH8320 (ART.1625/1 - 1/32) (NARROW)  
NH8321 (ART.1625/4 - 1/16)  
(RIGHT)  
NH8310 (ART.1625/2 - 1/32) (NARROW)  
NH8311N-1/16 (NARROW)  
NH8311 (ART.1625/5 - 1/16)  
NH8312 (ART.1625/6 - 1/8)  
NH8313 (ART.1625/7 - 3/16)  
NH8314 (ART.1625/8 - 1/4)  
NH8315 (ART.1625/9 - 5/16)  
NH8316 (ART.1625/10 - 3/8)

**HINGED FEET FOR NEEDLE FEED MACHINE CL.831**

**NH8331D-1/16**



DOUBLE  
NH8330D-1/32  
(ART.1625/3-1/32)  
NH8831D-1/16  
(ART.1625/3-1/16)

**NH363-1**

(ART.1643)



5.4mm

**NH36N-1**

(ART.1642)



5.4mm

**NH36LN-1**

(ART.1641)



5.4mm

**HINGED FEET FOR NEEDLE FEED MACHINE CL.831**

**CL831-NF1**

(ART.1615)



底部  
CL831-NFB  
(ART.1612/1)

**NH36-1**



7mm

**NH36L-1**



7mm

**PFAFF CL.442**

**PF264-1**

SIZE  
PF248-1  
(ART.1694/1 4.8mm)  
PF264-1  
(ART.1694/2 6.4mm)



**PRESSER FOOT FOR PFAFF CL.442**

**PFG264-2R**

SIZE  
PFG248-1R  
(ART.1695/1 4.8mm)  
PFG248-2R  
(ART.1695/2 4.8mm)  
PFG264-1R  
(ART.1696/1 6.4mm)  
PFG264-2R  
(ART.1696/2 6.4mm)



**PFG264-2L**

SIZE  
PFG248-1L  
(ART.1557/1 4.8mm)  
PFG248-2L  
(ART.1557/2 4.8mm)  
PFG264-1L  
(ART.1558/1 6.4mm)  
PFG264-2L  
(ART.1558/2 6.4mm)



## PRESSER FOOT FOR NECCHI

CL.971;974;976

### NH264N

SIZE  
NH248N  
(ART.1698/1 4.8mm)  
NH264N  
(ART.1698/2 6.4mm)



### NH264H

SIZE  
NH248H  
(ART.6645/1 4.8mm)  
NH264H  
(ART.6645/2 6.4mm)  
(HEAVY MATERIALS)



### NH264

SIZE  
NH248  
(ART.1623/1 4.8mm)  
(961799-3-00)  
NH260  
(ART.1623/2 6.0mm)  
(961773-3-00)  
Nh264  
(ART.1623/3 6.4mm)  
(961773-3-10)



### NHG264H

SIZE  
NHG248H  
(ART.6646/1 4.8mm)  
NHG264H  
(ART.6646/2 6.4mm)  
(HEAVY MATERIALS)



## PRESSER FOOT FOR NECCHI CL.971;974;976

### NHG264-2R

SIZE  
NHG248-2R  
(ART.1652/1 4.8mm)  
NHG264-2R  
(ART.1652/2 6.4mm)



### NHR264

SIZE  
NHR248  
(ART.1627/1 4.8mm)  
NHR264  
(ART.1627/2 6.4mm)



### NHD264

DOUBLE  
NHD248  
(ART.1679/1 4.8mm)  
NHD264  
(ART.1679/2 6.4mm)



THE PRODUCTS  
INTRODUCE  
AS BELOW

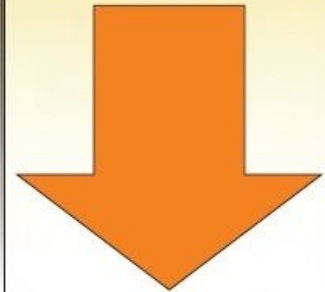

## ADJUSTABLE CLOTH GUIDE FOR DURKOPP MACHINE DURKOPP CL.212

### DK-10G



- 1.可以調整左,右擋邊尺寸.
- 2.車縫布條,可調整大小, 0~20mm
- 1.CAN ADJUSTABLE THE SIZE OF BOTH SIDE ON THE EDGE.
- 2.SEAM CLOTH CAN ADJUSTABLE THE TAPE SIZE. 0~20mm

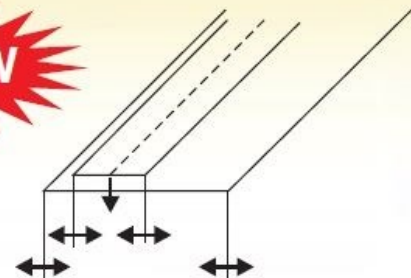

**PRESSER FOOT FOR DURKOPP**

**CL-212**

**DKMT-1**  
(ART.1603)

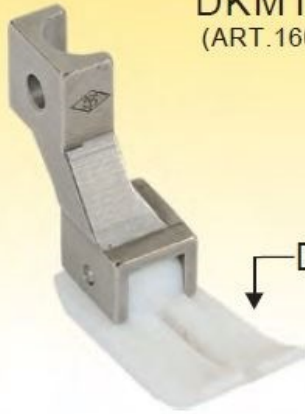

DKMT-1B

**DK36D**  
(ART.6647)



(DOUBLE)

**DK518N**



**DK518**



**Dk363**  
(ART.1623)



**DK363W**  
(ART.1685)



**DK36N**  
(ART.1682)



**DK36**  
(ART.1687)



**DK36LN**  
(ART.1681)



**DK36L**  
(ART.1686)



**PRESSER FEET FOR DUROPP CL-212**



**DK211** DK21R (ART.1620/2 -1/32)  
DK211 (ART.1620/4 -1/16)  
DK212 (ART.1620/6 -1/8)  
DK213 (ART.1620/8 -3/16)  
DK214 (ART.1620/10-1/4)  
DK215 (ART.1620/12-5/16)  
DK216 (ART.1620/14-3/8)  
DK218 (ART.1620/16-1/2)



**DK221** DK22L (ART.1620/1 -1/32)  
DK221 (ART.1620/3 -1/16)  
DK222 (ART.1620/5 -1/8)  
DK223 (ART.1620/7 -3/16)  
DK224 (ART.1620/9 -1/4)  
DK225 (ART.1620/11- 5/16)  
DK226 (ART.1620/13-3/8)  
DK228 (ART.1620/15-1/2)



**DK351**  
(212-1193)  
(ART.1309)

7/16



**DK127**  
(212-903)  
(ART.6650)

33/64



**DK127W**  
(212-1643)  
(ART.1289)

35/64



**DK127WK**  
(212-887)  
(ART.1285)

35/64

**DURKOPP W/GUIDE HINGED FEET**

CL.212

DK821-1/16



SIZE  
DK-820-1/32  
DK-821-1/16  
DK-822-1/8  
DK-823-3/16  
DK-824-1/4  
DK-825-5/16



DK811-1/16



SIZE  
DK-810-1/32  
DK-811-1/16  
DK-812-1/8  
DK-813-3/16  
DK-814-1/4  
DK-815-5/16



**BRASSIERE FOOT W/GUIDE (THE CLOTH EASY PASS THROUGH)**

SIZE(RIGHT)  
針距-邊距  
(NEEDLE)-(EDGE)  
S570S- 1/8 -1/32  
S570S- 3/16 -1/32  
S570S- 1/4 -1/32  
S570S- 5/16 -1/32  
S570S- 3/8 -1/32  
S570S- 1/2 -1/32



SIZE(LEFT)  
針距-邊距  
(NEEDLE)-(EDGE)  
S570SL- 1/8 -1/32  
S570SL- 3/16 -1/32  
S570SL- 1/4 -1/32  
S570SL- 5/16 -1/32  
S570SL- 3/8 -1/32  
S570SL- 1/2 -1/32



**BRASSIERE FOOT W/GUIDE (THE CLOTH EASY PASS THROUGH)**

SIZE(RIGHT)  
針距-邊距  
(NEEDLE)-(EDGE)  
S570S- 1/8-1/16  
S570S-3/16-1/16  
S570S- 1/4-1/16  
S570S-5/16-1/16  
S570S- 3/8-1/16  
S570S- 1/2-1/16



SIZE(LEFT)  
針距-邊距  
(NEEDLE)-(EDGE)  
S570SL- 1/8-1/16  
S570SL-3/16-1/16  
S570SL- 1/4-1/16  
S570SL-5/16-1/16  
S570SL- 3/8-1/16  
S570SL- 1/2-1/16



**BRASSIERE FOOT W/GUIDE (THE CLOTH EASY PASS THROUGH)**



**S570SD-1/4-1/32**  
SIZE(DOUBLE)  
針距-邊距  
(NEEDLE)-(EDGE)  
S570SD-1/8 -1/32  
S570SD-3/16-1/32  
S570SD-1/4 -1/32



**S570SD-1/4-1/16**  
SIZE(DOUBLE)  
針距-邊距  
(NEEDLE)-(EDGE)  
S570SD-1/8 -1/16  
S570SD-3/16-1/16  
S570SD-1/4 -1/16

**DOUBLE NEEDLE ADJUSTABLE EXTRA CLOTH GUIDE FEET**

**S570-A25**



SIZE  
S570-A25 1/8  
S570-A25 3/16  
S570-A25 1/4  
S570-A25 5/16  
調整式 5mm~50mm

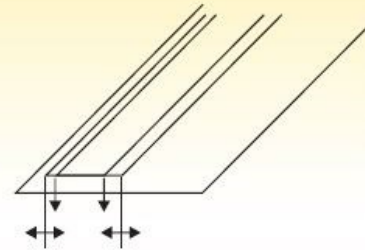

**DOUBLE NEEDLE ADJUSTABLE CLOTH GUIDE FEET**

**G10-570**

SIZE  
G10-570 1/8  
G10-570 3/16  
G10-570 1/4  
G10-570 5/16  
G10-570 3/8



SIZE  
1.可以調整左.右擋邊尺寸  
2.車縫布條.可調整大小. 0~20mm  
1.CAN ADJUSTABLE THE SIZE  
OF BOTH SIDE ON THE EGDE  
2.SEAM CLOTH CANADJUSTABLE  
THE TAPE SIZE. 0~20mm

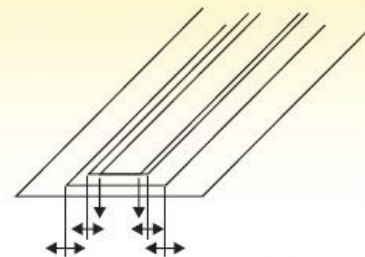

## DOUBLE NEEDLE WITH REMOVABLE GUIDE FEET

**NEW**

可以調整左、右擋邊尺寸  
CAN ADJUSTABLE THE SIZE  
OF BOTH SIDE ON THE EGDE

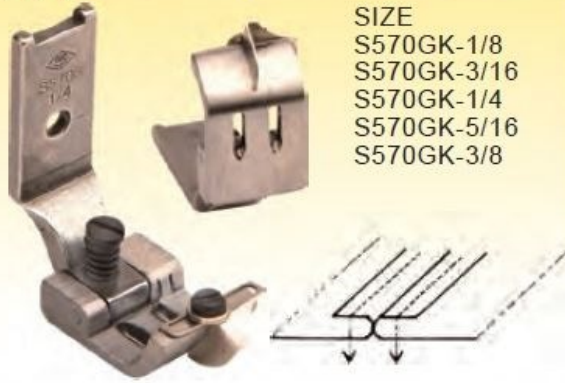

SIZE  
S570GK-1/8  
S570GK-3/16  
S570GK-1/4  
S570GK-5/16  
S570GK-3/8

## DOUBLE ROLLER FOOT

SIZE  
(NEEDLE)-(OUTER WIDTH)  
R-232-1/8 (HM7-1 1/8)  
R-248-3/16 (HM7-1 3/16)  
R-264-1/4 (HM7-1 1/4)  
R-280-5/16 (HM7-1 5/16)  
R-295-3/8 (HM7-1 3/8)



## ZIG-ZAG MACHINE EDGE GUIDE ADJUSTABLE FEET

G10-457

**NEW**



1. 可以調整左、右擋邊尺寸。  
2. 車縫布條，可調整大小 0~20mm。  
1. CAN ADJUSTABLE THE SIZE OF  
BOTH SIDE ON THE EGDE.  
2. SEAM CLOTH CAN ADJUSTABLE  
THE TAPE SIZE. 0~20mm

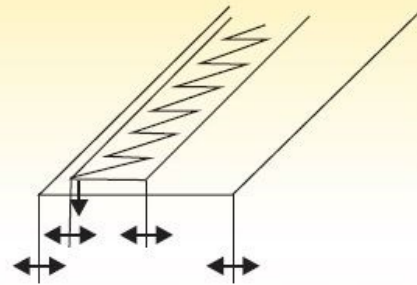

## ZIG-ZAG MACHINE ADJUSTABLE EXTRA SIZE FEET

**NEW**

107-A25



5mm~50mm

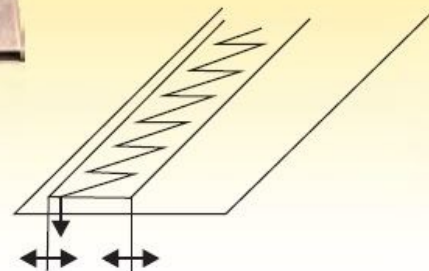



SINGER 457G; 457U; 107W ZIG-ZAG ADJUSTABLE FOOT

S457AT  
(503896)



車縫布條.可調整大小  
SEAM CLOTH CAN  
ADJUSTABLE THE  
TAPE SIZE  
5mm~20mm

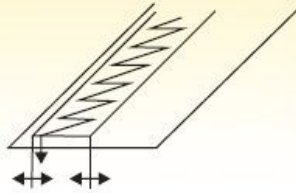

SINGER 457G; 457U; 107W ZIG-ZAG ADJUSTABLE FOOT

S457AT-G  
(503896-G)



車縫布條.可調整大小  
SEAM CLOTH CAN  
ADJUSTABLE THE  
TAPE SIZE  
5mm~20mm

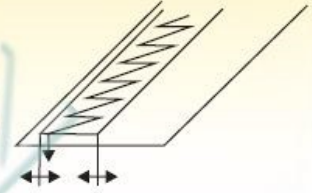

SINGER 457G; 457U; 107W ZZ REMOVE FEET

107GK

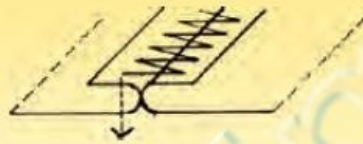

可以調整左.右擋邊尺寸  
CAN ADJUSTABLE THE  
SIZE OF BOTH SIDE ON  
THE EGDE

ZIG-ZAG ELASTIC FEET



107CA  
(23771S)

SIZE  
107CA-6mm  
107CA-8mm  
107CA-10mm  
107CA-12mm

ZIG-ZAG ROLLER FOOT



SIZE(針孔寬-外徑寬)  
NEEDLE SIZE - OUTER WIDTH  
R-457-1 7.5 -17.5(HM4-5)  
R-457-2 10.5 -20.5(HM4-7)  
R-457-3 12.5 -22.5  
R-457-4 15 -23.5(HM4-3)



ZIG-ZAG TEFLON COATED FEET



(針孔寬-外徑寬)  
NEEDLE SIZE - OUTER WIDTH  
CF457-1 5.0 -10  
CF457-2 7.5 -12  
CF457-3 7.5 -14  
CF457-4 10.5 -16  
CF457-5 12.5 -19  
CF457-6 14.5 -22.5

## ZIG-ZAG PRESSER FOOT For 107W;457G;457U etc.

411314



503660



503736



THE THREAD ENTER  
THE GROOVE ON  
THE FRONT SECTION



## ZIG-ZAG PRESSER FOOT For 107W;457G;457U etc.

23705  
(266125)



241414



107CR



107CL



## COMPENSATING FEET FOR 107W;457G;457U

PF-A1R



RIGHT  
PF-A1R

PF-A1L



LEFT  
PF-A1L

521ZR



521ZL



**ZIG-HEMMER FOOT**

457SH-2.0mm  
457SH-2.5mm  
457SH-3.0mm  
457SH-4.0mm  
457SH-5.0mm



**ZIG-PRESSER FOOT SINGER 111W; 211W FEET**

**P375**  
(241375)



3mm

**P375BL**



3mm

**P882**  
(229882)



**ZIG-ZAG EDGE GUIDE FEET For 107W;457G;457U**

**107SGR-2**



**107SGL-2**



**ZIG-ZAG EDGE GUIDE FEET FOR 107W;457U;457G**

**107SGR-4**



**107SGL-4**



**ZIG-ZAG BINDER FEET**



**ZIG-ZAG BRASSIRE FOOT**

適用直線(LONG BOTTOM)      外寬-針孔寬  
OUTER WIDTH-NEEDLESINE



**NEW**

- SIZE
- 457-01X10.2mm -6.2mm
  - 457-02X12 mm -7.5mm
  - 457-03X14 mm -7.5mm
  - 457-04X16 mm -10.5mm
  - 457-05X19 mm -12.5mm
  - 457-06X22 mm -14.5mm

適用轉角(SHORT BOTTOM)      外寬-針孔寬  
OUTER WIDTH-NEEDLESINE



**NEW**

- SIZE
- 457-1X10.2mm-6.2mm
  - 457-2X12 mm-7.5mm
  - 457-3X14 mm-7.5mm
  - 457-4X16 mm-10.5mm
  - 457-5X19 mm-12.5mm
  - 457-6X22 mm-14.5mm

**INVISIBLE CUTTER THREAD FEET**



ZIG-ZAG THICKER MATERIAL FEET

503595  
503595-G



厚物(HEAVY)

ZIG-ZAG LIGHT MATERIAL FEET

503595HK  
503595HK-G



薄物(LIGHT)

ZIG-ZAG THICKER MATERIAL FEET

503689  
503689-G



厚物(HEAVY)

ZIG-ZAG LIGHT MATERIAL FEET

503689HK  
503689HK-G



薄物(LIGHT)

ZIG-ZAG STANDARD FEET

411215  
411215-G

標準押布腳  
STANDARD FEET



ZIG-ZAG STANDARD FEET

503818  
503818-G

標準押布腳  
STANDARD FEET



<p><b>SINGLE NEEDLE FOR ALL MACHINE</b></p> <p>150384-0-01</p> <p>可加裝在各廠牌單針安全保護套 THE SAFETY GUARD USE ON ALL KIND OF MACHINE FOR SINGLE NEEDLE.</p> <p>150384-0-01 → </p>	<p><b>FOR SINGER SINGLE NEEDLE MACHINES</b></p> <p>Classes:95;96;400W; 600w;31-15;241;251 ETC. NEEDLE GUARD #G5</p> 		<p><b>FOR PFAFF Classes: 461;462;463;467;469; 483;434;ETC.</b></p> <p>NEEDLE GUARD #19S(#61231A)</p> 
<p><b>FOR SINGER Classes: 112W;212W;ETC.</b></p> <p>NEEDLE GUARD #14R</p> 	<p><b>FOR SINGER Classes: 107W;111W;143W;153K; 153W;457G;ETC.</b> SINGLE NEEDLE MACHINE</p> <p>NEEDLE GUARD #259081 (#225365)</p> 	<p><b>FOR WW DOUBLE NEEDLE MACHINES</b></p> <p>NEEDLE GUARD #22G</p> 	<p><b>FOR SINGER Classes: 108W AND WW SINGLE NEEDLE MACHINE</b></p> <p>NEEDLE BUARD #16A</p> 
<p><b>3 NEEDLE EDGE GUIDE WITH ROLLER ADJUSTABLE FEET</b></p> <p><b>R-3DW-G10</b></p> <p>1.可以調整左,右擋邊尺寸. 2.車縫布條,可調整大小, 0~20mm 1.CAN ADJUSTABLE THE SIZE OF BOTH SIDE ON THE EGDE. 2.SEAM CLOTH CAN ADJUSTABLE</p> <p>THE TAPE SIZE. 0~20mm</p> <p><b>NEW</b></p>  <p>SIZE 4.8mm 5.6mm 6.4mm</p>		<p><b>3 NEEDLE EDGE GUIDE WITH ROLLER FEET</b></p> <p><b>R-3DWG</b></p> <p>可以調整左,右擋邊尺寸 CAN ADJUSTABLE THE SIZE OF BOTH SIDE ON THE EGDE.</p> <p><b>NEW</b></p>  <p>SIZE 4.8mm 5.6mm 6.4mm</p>	<p><b>3 NEEDLE TEFLON COATED FOOT</b></p> <p><b>CF3DW</b></p> <p>SIZE 4.8mm 5.6mm 6.4mm</p> 

**3 STITCHING OVERLOCKED SEAM FOR BROTHER PEGASUS SIRUBA**

R3-1(HM6-1-1)



THE DRAWING FOR REFERENCE ONLY, IT BASE ON DIFFERENT OF FEET. (僅供參考, 以實物為準)

**4 STITCHING OVERLOCKED SEAM FOR YAMATO PEGASUS JUKI**

R4-2 (HM6-1-4)

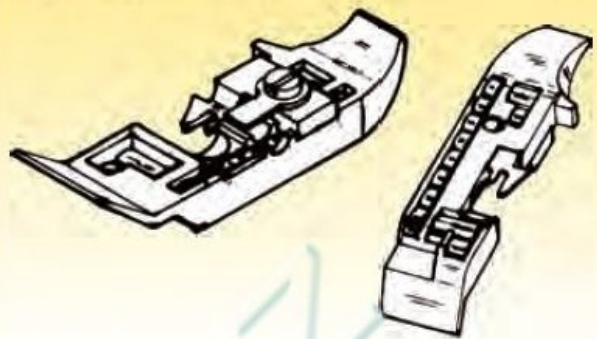

THE DRAWING FOR REFERENCE ONLY, IT BASE ON DIFFERENT OF FEET. (僅供參考, 以實物為準)

**3 STITCHING OVERLOCKED SEAM FOR YAMATO SIRUBA JUKI PEGASUS**

R3-2(HM6-1-3)

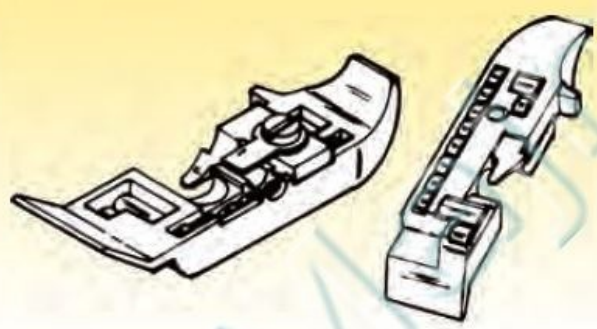

THE DRAWING FOR REFERENCE ONLY, IT BASE ON DIFFERENT OF FEET. (僅供參考, 以實物為準)

**5 STITCHING OVERLOCKED SEAM FOR PEGASUS SIRUBA**

R5-1X 3mm(HM6-2-1X 3mm)  
R5-1X 5mm(HM6-2-1X 5mm)



THE DRAWING FOR REFERENCE ONLY, IT BASE ON DIFFERENT OF FEET. (僅供參考, 以實物為準)

**4 STITCHING OVERLOCKED SEAM FOR BROTHER PEGASUS SIRUBA**

R4-1(HM6-1-2)



THE DRAWING FOR REFERENCE ONLY, IT BASE ON DIFFERENT OF FEET. (僅供參考, 以實物為準)

**5 STITCHING OVERLOCKED SEAM FOR JUKI KINTEX**

R5-2X 3mm(HM6-2-2X 3mm)  
R5-2X 5mm(HM6-2-2X 5mm)



THE DRAWING FOR REFERENCE ONLY, IT BASE ON DIFFERENT OF FEET. (僅供參考, 以實物為準)

## TURRET TO TAKE 3 PRESSER FEET

154628-0-01(FOR BROTHER)



(PRESSER FOOT NOT INCLUDED)

MAS-07300-AA0  
(FOR JUKI)



#SS1  
#PB-3  
#NBBF

SCREW/SPRING ITEM NO	LENGTH	APPURTENANCE SUITABLE FOR LENGTH 適用 配 件 / 尺 寸 表	UNIT PRICE NT\$
CFS-1	13.5mm	CR/CL1/32E(K),CR/CL1/16E(K),CR/CL3/32E(K), CR/CL10,CR/CL15,CR/CL20,CR/CL25, 21R,211R,22L,221,211 1/2,221 1/2.	3
CFS-2	14.5mm	CR/CL1/8E(K),CR/CL30,212,222.	3
CFS-3	16mm	CR/CL3/16E(K),CD0.8/1.0mm,213,223,231.	3
CFS-4	17.5mm	CR/CL1/4E(K),CD-20,CR/CL65, CR/CL70,214,224	3
CFS-5	10.5mm	CR/CL1/32N(K),CR/CL1/16N(K), CR/CL10N,CR/CL15N,210,211N,220,221N.	3
CFS-6	20.5mm	CR/CL3/8E(K)CR/CL90,CR/CL95, CR/CL100,216,226,21-16.	3
CFS-7	19mm	CR/CL5/16E(K),CR/CL80,215,225	3
CFS-8	21.5mm	CD-30,D232.	3
CFS-9	18mm	211-14.	3
CFS-10	3mmx0.5	21-14~211-18 (内角螺絲)	3
CFS-11	19.5mm	211-14,21-14	3
CFS-12	19.5mm		3
CFS-13	24mm	CR/CL1/2E(K),21-18,D233.	3
CFS-14	25mm	D234	3
CSP-1	2.5x8mm	CR/CL1/32N(K),CR/CL1/16N(K), (B20)	0.5
CSP-2	2.8x8mm	CR/CL1/32E(K),CR/CL1/2E(K), (B25)	0.5
CSP-4	2.0x8.5mm	211-14,211-18	0.5
CSP-5	3.0x8mm	21R~218,22L~228 ,T36N,T36LN,T363 (B30U)	0.5



## CONVERSION TABLE INCH / MILIMETER

(吋) INCH	(mm) MILIMETER	(吋) INCH	(mm) MILIMETER	(吋) INCH	(mm) MILIMETER
1/64"	0.40mm	25/64"	9.92mm	29/32"	23.02mm
1/32"	0.79mm	13/32"	10.32mm	15/16"	23.81mm
3/64"	1.19mm	27/64"	10.72mm	31/32"	24.61mm
1/16"	1.59mm	7/16"	1.11mm	63/64"	25.00mm
5/64"	1.98mm	29/64"	11.51mm	1"	25.40mm
3/32"	2.38mm	15/32"	11.91mm	1-1/8"	28.58mm
7/64"	2.78mm	31/64"	12.30mm	1-1/4"	31.75mm
1/8"	3.18mm	1/2"	12.70mm	1-3/8"	34.93mm
9/64"	3.57mm	33/64"	13.10mm	1-1/2"	38.10mm
5/32"	3.97mm	17/32"	13.49mm	1-3/4"	44.45mm
11/64"	4.37mm	35/64"	13.89mm	2"	50.80mm
3/16"	4.76mm	9/16"	14.29mm	2-1/4"	57.15mm
13/64"	5.16mm	37/64"	14.68mm	2-1/2"	63.50mm
7/32"	5.56mm	19/32"	15.08mm	2-3/4"	69.85mm
15/64"	5.95mm	39/64"	15.48mm	3"	76.20mm
1/4"	6.35mm	5/8"	15.88mm	3-1/4"	82.55mm
17/64"	6.75mm	21/32"	16.67mm	3-1/2"	88.90mm
9/32"	7.14mm	11/16"	17.46mm	3-3/4"	95.25mm
19/64"	7.54mm	23/32"	18.26mm	4"	101.60mm
5/16"	7.94mm	3/4"	19.05mm	4-1/4"	107.95mm
21/64"	8.33mm	25/32"	19.84mm	4-1/2"	114.30mm
11/32"	8.73mm	13/16"	20.64mm	4-3/4"	120.65mm
23/64"	9.13mm	27/32"	21.43mm	5"	127.00mm
3/8"	9.53mm	7/8"	22.23mm	6"	152.40mm

02 (1/8).....	11	210-NF (NARROW-1/32).....	24	225S-NF (ART.1649/11-5/16).....	24
04 (3/16).....	11	210S-NF (NARROW-1/32).....	24	226-NF (ART.1649/16-3/8).....	24
06 (1/4).....	11	211-13 (1/16x3/16).....	4	226S-NF (ART.1649/13-3/8).....	24
1 (160344-1/16).....	11	211-14 (1/16x1/4).....	4	228-NF (ART.1649/15-1/2).....	24
1 1/2 (120-802-1 1/2).....	11	211-15 (1/16x5/16).....	4	228S-NF (ART.1649/15-1/2).....	24
107-A25 (5~50mm).....	40	211-16 (1/16x3/8).....	4	22G.....	46
107CA-10MM(23771S).....	41	211-18 (1/16x1/2).....	4	22L-NF (ART.1649/1-1/32).....	24
107CA-12MM(23771S).....	41	21-13 (1/32x3/16).....	4	22LS-NF (ART.1649/1-1/32).....	24
107CA-6MM (23771S).....	41	21-14 (1/32x1/4).....	4	230ZZ3mm(ART.1629/3).....	31
107CA-8MM (23771S).....	41	21-15 (1/32x5/16).....	4	230ZZ5mm(ART.1629/5).....	31
107CL.....	42	21-16 (1/32x3/8).....	4	231-13-23 (1/16-3/16-3/16).....	4
107CR.....	42	21-18 (1/32x1/2).....	4	231-14-24 (1/16-1/4-1/4).....	4
107GK (外徑19MM~12MM針孔寬).....	41	211-NF (ART.1649/4-1/16).....	24	231-15-25 (1/16-5/16-5/16).....	4
107SGL-2.....	43	211N-NF (NARROW-1/16).....	24	23-13-23 (1/32-3/16-3/16).....	4
107SGL-4.....	43	211NS-NF(NARROW-1/16).....	24	23-14-24 (1/32-1/4-1/4).....	4
107SGR-2.....	43	211S-NF (ART.1649/4-1/16).....	24	23-15-25 (1/32-5/16-5/16).....	4
107SGR-4.....	43	212-NF (ART.1649/6-1/8).....	24	23705 (266125).....	42
111994-0-01-12MM(652-12mm).....	32	212S-NF (ART.1649/6-1/8).....	24	241414.....	42
112800-0-01-5MM(652-5mm).....	32	213-NF (ART.1649/8-3/16).....	24	24983T.....	23
113280(113280-0-01).....	16	213S-NF (ART.1649/8-3/16).....	24	259081 (225365).....	46
12142AHB.....	10	214-NF (ART.1649/10-1/4).....	24	25L-NF (3/32).....	24
12142AHBNF.....	28	214S-NF (ART.1649/10-1/4).....	24	25LS-NF (3 /32).....	24
140717-NF(140717).....	29	215-NF (ART.1649/12-5/16).....	24	25R-NF (3/32).....	24
147308 (ART.570).....	17	215S-NF (ART.1649/12-5/16).....	24	25RS-NF (3 /32).....	24
14R.....	46	216-NF (ART.1649/14-3/8).....	24	26473 (91-026473-05).....	33
150384-0-01.....	46	216S-NF (ART.1649/14-3/8).....	24	26474 (91-026474-05).....	33
150789 (150789-0-01).....	16	218-NF (ART.1649/16-1/2).....	24	26650DG-1/8.....	9
154628-0-01.....	48	218S-NF (ART.1649/16-1/2).....	24	26650L-1/8.....	8
160342.....	17	21R-NF (ART.1649/2-1/32).....	24	26650R-1/8.....	8
16-32 (1/16-1/8).....	4	21RS-NF (ART.1649/2-1/32).....	24	282139.....	44
16-48 (1/16-3/16).....	4	220-NF (NARROW-1/32).....	24	282140.....	44
16-64 (1/16-1/4).....	4	220S-NF (NARROW-1/32).....	24	2CJ1 (NP-63P-2)(尖).....	14
16-80 (1/16-5/16).....	4	221-NF (ART.1649/3-1/16).....	24	3 (120804-5/32).....	11
16A (490607).....	46	221N-NF (NARROW-1/16).....	24	368607.....	22
19S (61231A).....	46	221NS-NF(NARROW-1/16).....	24	368611.....	22
2 (120938-3/32).....	11	221S-NF (ART.1649/3-1/16).....	24	3CJ1 (NP-63P-1)(平).....	14
2 1/2 (120938-1/8).....	11	222-NF (ART.1649/5-1/8).....	24	4 (120805-3/16).....	11
20L-NF (5/64).....	24	222S-NF (ART.1649/5-1/8).....	24	411215 (標準型).....	45
20LS-NF(5/64).....	24	223-NF (ART.1649/7-3/16).....	24	411215-G (標準型).....	45
20R-NF (5/64).....	24	223S-NF (ART.1649/7-3/16).....	24	411314 (標準型).....	42
20RS-NF(5/64).....	24	224-NF (ART.1649/9-1/4).....	24	411314-1X 6.5mm(針孔寬).....	42
210562A2.....	44	224S-NF (ART.1649/9-1/4).....	24	411314-2X 7.5mm(針孔寬).....	42
210564A4.....	44	225-NF (ART.1649/11-5/16).....	24	411314-3X10.5mm(針孔寬).....	42

\* DK-DURKOPP \*NH-NECCHI

\* BROTHER \* JUKI \* PEGASUS \* SINGER

\*I

\* Majmasz

411314-4X12.5mm(針孔寬).....42	543939 12mm.....31	A227-1/4 (S537-1/4).....11
411314-5X14.5mm(針孔寬).....42	54501 (91-054501-03C)....31	A227-1/8 (S537-1/8).....11
43522A(91-043522-03).....33	54501-G (91-054501-03C)....31	A227-3/16 (S537-3/16).....11
457-01(適用直行)(10.2- 6.2).....44	54926-G 1/4 (91-054926-03)....33	A227-3/8 (S537-3/8).....11
457-02(適用直行)(12 - 7.5).....44	54926-G 3/16(91-054926-03)....33	A227-5/16 (S537-5/16).....11
457-03(適用直行)(14 - 7.5).....44	54926-G 9/32(91-054926-03)....33	B1511-543-BBA.....17
457-04(適用直行)(16 - 10.5).....44	55106CX-10mm(91-055106-23/006)....31	B1524-012-BBA .....18
457-05(適用直行)(19 - 12.5).....44	55112B-G-4.5mm(91-055112-23/002)....31	B1524-012-OAO.....18
457-06(適用直行)(22 - 14.5).....44	5G.....46	B1524-012-OBO.....18
457-1(適用轉角)(10.2- 6.2).....44	6 (120806-1/4).....11	B1524-012-OOC.....18
457-2(適用轉角)(12 - 7.5).....44	610NP (1/32-NARROW).....32	B1524-041-EAO.....28
457-3(適用轉角)(14 - 7.5).....44	611NP (1/16-NARROW).....32	B1524-412-OAO.....28
457-4(適用轉角)(16 - 10.5).....44	611P (1/16-RIGHT).....32	B1524-412-OBO(410916).....28
457-5(適用轉角)(19 - 12.5).....44	61220J.....21	B1524-415-BBA .....28
457-6(適用轉角)(22 - 14.5).....44	61220P.....21	B1524-522-NBO-A-1/8.....17
457SH-2.0mm(人字車三卷押腳)....43	612P (1/8-RIGHT).....32	CB 1 1/4 (604).....10
457SH-2.5mm(人字車三卷押腳)....43	61320J.....21	CB 1 1/8 (603).....10
457SH-3.0mm(人字車三卷押腳)....43	613P (3/16-RIGHT).....32	CB 1" (602).....10
457SH-4.0mm(人字車三卷押腳)....43	614P (1/4-RIGHT).....32	CB 3/4 (601).....10
457SH-5.0mm(人字車三卷押腳)....43	620NP (1/32-NARROW).....32	CD-00 (23).....4
46682(91-046682-03).....33	621P (1/16-LEFT).....32	CD-1/16 (D231).....4
5(120940-7/32).....11	630P (1/32-DOUBLE).....32	CD-1/32 (D23).....4
503595厚物(HEAVY).....45	630ZZ-3mm(91-0511863-93)....32	CD-1/4 (D234)(CD-64).....4
503595-G厚物(HEAVY).....45	630ZZ-5mm(91-0511863-93)....32	CD-1/8 (D232)(CD-32).....4
503595HK薄物(LIGHT).....45	631P (1/16-DOUBLE).....32	CD-10 (1.0mm).....4
503595HK-G薄物(LIGHT).....45	652-35 (ART.1468).....31	CD-15 (1.5mm).....4
503660.....42	652LZ (ART.1699/1).....31	CD-20 (2.0mm).....4
503689厚物(HEAVY).....45	652RZ (ART.1699).....31	CD-3/16 (D233).....4
503689-G厚物(HEAVY).....45	652SH-3mm.....31	CDN-00 (230).....4
503689HK薄物(LIGHT).....45	652SH-5mm.....31	CDN-1/32 (D23N).....4
503689HK-G薄物(LIGHT).....45	8-32 (1/32-1/8).....4	CDN-1/6 (D231N).....4
503736.....42	8-48 (1/32-3/16).....4	CF351 11mm.....7
503818(標準型).....45	8-64 (1/32-1/4).....4	CF35 11mm.....7
503818-G(標準型).....45	8-80 (1/32-5/16).....4	CF351W 12.7mm.....7
51742-1.8mm.....18	990474-0-01.....4	CF360 8mm.....7
51742-2.2mm(91-051742-03).....18	A10-01-1 1/2 (12142C-1 1/2)....9	CF361 8mm.....7
51742-G(1.8mm).....18	A10-01-1 1/4 (12142C-1 1/4)....9	CF363 4.8mm.....7
51742-G(2.2mm)(91-051742-03)....18	A10-01-1 1/8 (12142C-1 1/8)....9	CF363V 4.8mm.....7
520-4.....10	A10-01-1 3/8 (12142C-1 3/8)....9	CF363VNF 4.8mm.....7
521ZL(521Z).....42	A10-01-1" (12142C-1").....9	CF36 8mm.....7
521ZR.....42	A10-01-3/4 (12142C-3/4).....9	CF36L 8mm.....7
541566-10mm.....31	A10-01-7/8 (12142C-7/8).....9	CF36LN 4.6mm.....7
541781-10mm.....31	A227-1/2 (S537-1/2).....11	CF36LW 10mm.....7

\* DK-DURKOPP \*NH-NECCHI

\* BROTHER \* JUKI \* PEGASUS \* SINGER

\*I

\* *Majmasz*

CF36N 4.6mm.....	7	CL1/16NS.....	2	CL3/32K (221-1/2H).....	2
CF36W 10mm.....	7	CL1/16S.....	3	CL3/32S.....	3
CF3CH 4.8mm.....	7	CL1/2.....	3	CL3/8.....	3
CF3CSH 4.8mm.....	7	CL1/2E (228L).....	2	CL3/8E (226L).....	2
CF3DW 4.8mm.....	46	CL1/2ES.....	2	CL3/8ES.....	2
CF3DW 5.6mm.....	46	CL1/2K (228H).....	2	CL3/8K (226H).....	2
CF3DW 6.4mm.....	46	CL1/2S.....	3	CL3/8S.....	3
CF457-1 (5.0 - 10).....	41	CL1/32.....	3	CL-30-3.0mm.....	3
CF457-2 (7.5 - 12).....	41	CL1/32E (22L).....	2	CL-40-4.0mm.....	3
CF457-3 (7.5 - 14).....	41	CL1/32ES.....	2	CL5/16.....	3
CF457-4 (10.5 - 16).....	41	CL1/32K (22H).....	2	CL5/16E (225L).....	2
CF457-5 (12.5 - 19).....	41	CL1/32N (220L).....	2	CL5/16ES.....	2
CF457-6 (14.5 - 22).....	41	CL1/32NK (220H).....	2	CL5/16K (225H).....	2
CF58N 8mm.....	7	CL1/32NN (220LN).....	2	CL5/16S.....	3
CF810-1/32.....	6	CL1/32NS.....	2	CL5/32.....	3
CF810L-1/32.....	6	CL1/32S.....	3	CL5/32E (222-1/2).....	2
CF811-1/16.....	6	CL1/4.....	3	CL5/32ES.....	2
CF8115-3/32.....	6	CL1/4E (224L).....	2	CL5/32K (222-1/2H).....	2
CF8115L-3/32.....	6	CL1/4ES.....	2	CL5/32S.....	3
CF811L-1/16.....	6	CL1/4K (224H).....	2	CL-50-5.0mm.....	3
CF812-1/8.....	6	CL1/4S.....	3	CL-60-6.0mm.....	3
CF812L-1/8.....	6	CL1/8.....	3	CL-65-6.5mm.....	3
CF813-3/16.....	6	CL1/8E (222L).....	2	CL-70-7.0mm.....	3
CF813L-3/16.....	6	CL1/8ES.....	2	CL-80-8.0mm.....	3
CF814-1/4.....	6	CL1/8K (222H).....	2	CL831-NF1.....	34
CF814L-1/4.....	6	CL1/8S.....	3	CL831-NFB(ART.1612/1).....	34
CF815-5/16.....	6	CL-100-10mm.....	3	CL-90-9.0mm.....	3
CF815L-5/16.....	6	CL-10-1.0mm.....	3	CR1/16.....	3
CF816-3/8.....	6	CL10N-1.0mm.....	3	CR1/16E (211R).....	2
CF816L-3/8.....	6	CL-110-11mm.....	3	CR1/16ES.....	2
CF818-1/2.....	6	CL-130-13mm.....	3	CR1/16K (211H).....	2
CF818L-1/2.....	6	CL-15-1.5mm.....	3	CR1/16S.....	3
CHNR-1/16 (KR-1-1/16).....	10	CL-15N-1.5mm.....	3	CR1/16N (211N).....	2
CHNR-1/32 (KR-1-1/32).....	10	CL-20-2.0mm.....	3	CR1/16NK (211NH).....	2
CHNL-1/16 (KL-1-1/16).....	10	CL-25-2.5mm.....	3	CR1/16NN (211NN).....	2
CHNL-1/32 (KL-1-1/32).....	10	CL3/16.....	3	CR1/16NS.....	2
CL1/16.....	3	CL3/16E (223L).....	2	CR1/2.....	3
CL1/16E (221L).....	2	CL3/16ES.....	2	CR1/2E (218R).....	2
CL1/16ES.....	2	CL3/16K (223H).....	2	CR1/2ES.....	2
CL1/16K (221H).....	2	CL3/16S.....	3	CR1/2K (218H).....	2
CL1/16N (221N).....	2	CL3/32.....	3	CR1/2S.....	3
CL1/16NK (221NH).....	2	CL3/32E (221-1/2).....	2	CR1/32.....	3
CL1/16NN (221NN).....	2	CL3/32ES.....	2	CR1/32E (21R).....	2

\* DK-DURKOPP \*NH-NECCHI \*F

\* BROTHER \* JUKI \* PEGASUS \* SINGER

\* \* *Majmasz*

CR1/32ES.....	2	CR5/16.....	3	DK36D (ART.6647).....	36
CR1/32K (21H) .....	2	CR5/16E (215R).....	2	DK36L (ART.1686).....	36
CR1/32N (210R).....	2	CR5/16ES.....	2	DK36LN (ART.1681).....	36
CR1/32NK (210H).....	2	CR5/16K(215H) .....	2	DK36N (ART.1682).....	36
CR1/32NN (210RN).....	2	CR5/16S.....	3	DK518.....	36
CR1/32NS.....	2	CR5/32.....	3	DK518N.....	36
CR1/32S.....	3	CR5/32E (212-1/2).....	2	DK-810 1/32.....	38
CR1/4.....	3	CR5/32ES.....	2	DK-811 1/16.....	38
CR1/4E (214R).....	2	CR5/32K(212-1/2H).....	2	DK-812 1/8.....	38
CR1/4ES.....	2	CR5/32S.....	3	DK-813 3/16.....	38
CR1/4K (214H).....	2	CR-50-5.0mm.....	3	DK-814 1/4.....	38
CR1/4S.....	3	CR-60-6.0mm.....	3	DK-815 5/16.....	38
CR1/8.....	3	CR-65-6.5mm.....	3	DK-820 1/32.....	38
CR1/8E (212R).....	2	CR-70-7.0mm.....	3	DK-821 1/16.....	38
CR1/8ES.....	2	CR-80-8.0mm.....	3	DK-822 1/8.....	38
CR1/8K (212H).....	2	CR-90-9.0mm.....	3	DK-823 3/16.....	38
CR1/8S.....	3	D-1421-555-DOO.....	17	DK-824 1/4.....	38
CR-100-10mm.....	3	D36H-8.0mm.....	14	DK-825 5/16.....	38
CR-10-1.0mm.....	3	D36NH-4.8mm.....	14	DKMT-1 (ART .1603).....	36
CR-10N-1.0mm.....	3	DK-10G (0~20mm)(DK10G-CRL).....	35	DKMT-1B.....	36
CR-110-11mm.....	3	DK127 (212-903)(ART.6650).....	37	G10-457 (0~20mm)(G10-457-CRL).....	40
CR-130-13mm.....	3	DK127W (212-1643)(ART.1289).....	37	G10-570 1/4(0~20mm)(G10-570-CRL).....	39
CR-15-1.5mm.....	3	DK127WK(212-887)(ART.1285).....	37	G10-570 1/8(0~20mm)(G10-570-CRL).....	39
CR-15N-1.5mm.....	3	DK211 (ART.1620/4-1/16).....	37	G10-570 3/16(0~20mm)(G10-570-CRL).....	39
CR-20-2.0mm.....	3	DK212 (ART.1620/6-1/8).....	37	G10-570 3/8 (0~20mm)(G10-570-CRL).....	39
CR-25-2.5mm.....	3	DK213 (ART.1620/8-3/16).....	37	G10-5705/16(0~20mm)(G10-570-CRL).....	39
CR3/16.....	3	DK214 (ART.1620/10-1/4).....	37	G10-652 (0~20mm)(G10-652-CRL).....	30
CR3/16E (213R).....	2	DK215 (ART.1620/12-5/16).....	37	G10-CRL (0~20mm)(G10-CRL).....	1
CR3/16ES.....	2	DK216 (ART.1620/14-3/8).....	37	G10-NF (0~20mm)(G10-NF-CRL).....	26
CR3/16K (213H).....	2	DK218 (ART.1620/16-1/2).....	37	H10-1.0mm.....	21
CR3/16S.....	3	DK21R (ART.1620/2-1/32).....	37	H15-1.5mm (ART.1926/1).....	21
CR3/32.....	3	DK221 (ART.1620/3-1/16).....	37	H15-69HL1/4-6.4mm.....	21
CR3/32E (21 1-1/2).....	2	DK222 (ART.1620/5-1/8).....	37	H15-69HL1/8-3.2mm.....	21
CR3/32ES.....	2	DK223 (ART.1620/7-3/16).....	37	H15-69HL3/16-4.8mm.....	21
CR3/32K (211-1/2H).....	2	DK224 (ART.1620/9-1/4).....	37	H15SH 2.0mm(2858).....	21
CR3/32S.....	3	DK225 (ART.1620/11-5/16).....	37	H15SH 2.5mm(2858).....	21
CR3/8.....	3	DK226 (ART.1620/13-3/8).....	37	H15SH 3.0mm(2858).....	21
CR3/8E (216R).....	2	DK228 (ART.1620/15-1/2).....	37	H15SH 4.0mm(2858).....	21
CR3/8ES.....	2	DK22L (ART.1620/1-1/32).....	37	H15ZZ-3.0mm(ART.1929).....	21
CR3/8K (216H).....	2	DK351 (212-1193)(ART.1309).....	37	H15Z.....	21
CR3/8S.....	3	DK36 (ART.1687).....	36	H15ZZ-6.0mm(ART.1929).....	21
CR-30-3.0mm.....	3	DK363 (ART.1623).....	36	H20-2.0mm.....	21
CR-40-4.0mm.....	3	DK363W (ART.1685).....	36	H25-2.5mm (ART.1926/2).....	21

\* DK-DURKOPP \*NH-NECCHI

\* BROTHER \* JUKI \* PEGASUS \* SINGER

\*f

\* 'Majmasz

H30-3.0mm (ART.1926/3).....	21	LF-60-6.0mm.....	5	NH8320 (ART.1625/1-1/32)(NARROW)....	33
H40-4.0mm (ART.1926/4).....	21	LF-65-6.5mm.....	5	NH8321 (ART.1625/4-1/16)....	33
H50-5.0mm (ART.1926/5).....	21	LF-70-7.0mm.....	5	NH8330D-DOUBLE (ART.1625/3-1/32)....	33
H60-6.0mm (ART.1926/6).....	21	LF-80-8.0mm.....	5	NH8331D-DOUBLE (ART.1625/3-1/16)....	34
K1 NEEDLE PLATE.....	20	LF-90-9.0mm.....	5	NH8810(ART.1626/2-1/32).....	29
K2 FEED DOG.....	20	MAS-07300-AA0 (#SS1 #PB-3 #NBBF)48		NH8811 (ART.1626/4-1/16)....	29
K3 FOOT.....	20	MT-1.....	23	NH8811N-1/16(NARROW)....	29
LF1/16.....	5	MT1-NF (ART.1602).....	29	NH8812 (ART.1626/5-1/8).....	29
LF1/16K (PF221L).....	5	MT1-NFB.....	29	NH8813 (ART.1626/6-3/16).....	29
LF1/16N.....	5	MT-2.....	23	NH8814 (ART.1626/7-1/4).....	29
LF1/16NK (PF221N).....	5	MT541566 12mm.....	32	NH8815 (ART.1626/8-5/16).....	29
LF1/2.....	5	MT541566 5mm.....	32	NH8816 (ART.1626/9-3/8).....	29
LF1/2K (PF228L).....	5	MT541566B 12mm.....	32	NH8820 (ART.1626/1-1/32).....	29
LF1/32.....	5	MT541566B 5mm.....	32	NH8821 (ART.1626/3-1/16).....	29
LF1/32K (PF22L).....	5	NH-10G-0~20mm (NH10G-CRL).....	29	NH8821N-1/16(NARROW).....	29
LF1/32N.....	5	NH127 13mm.....	30	NHD248 (ART.1679/1 4.8mm-2.0mm)....	35
LF1/32NK (PF220L).....	5	NH127W 14mm.....	30	NHD264 (ART.1679/2 6.4mm-2.0mm)....	35
LF1/4.....	5	NH248 (ART.1623/1 4.8mm)(#961799-3-00).....	35	NHG248-2R(ART.1652/1 4.8mm-2.0mm).....	35
LF1/4K (PF224L).....	5	NH248H (ART.6645/1 4.8mm).....	35	NHG248H(ATR.6646/1 4.8mm-2.0mm)....	35
LF1/8.....	5	NH248N (ART.1698/1 4.8mm).....	35	NHG264-2R(ART.1652/2 6.4mm-2.0mm).....	35
LF1/8K (PF222L).....	5	NH260(ART.1623/2 6mm)(#961773-3-00).....	35	NHG264H (ART.6646/2 6.4mm-2.0mm)....	35
LF-100-10mm.....	5	NH264 (ART.1623/3 8.4mm)(#961773-3-10).....	35	NHR248 (ART.1627/1 4.8mm-2.0mm)....	35
LF-10-1.0mm.....	5	NH264H (ART.6645/2 6.4mm).....	35	NHR264 (ART.1627/2 6.4mm-2.0mm)....	35
LF-10N-1.0mm.....	5	NH264N(ART.1698/2 6.4mm).....	35	NL-31G.....	1
LF-120-12mm.....	5	NH35(ART.1551) (#961789-3-00) 11mm.....	30	NL31G-NF.....	26
LF-130-13mm.....	5	NH351 11mm.....	30	NR-31G.....	1
LF-15-1.5mm.....	5	NH351W(ART.1552)(#961761-3-00)12.7mm.....	30	NR-31G-NF.....	26
LF-15N-1.5mm.....	5	NH36-1 7.0mm.....	34	NT-18.....	24
LF-20-2.0mm.....	5	NH363 (ART.1646) 5.4mm.....	30	NT-18B.....	24
LF-25-2.5mm.....	5	NH363-1 (ART.1643) 5.4mm.....	34	P01 (36464N).....	24
LF3/16.....	5	NH36L-1 7.0mm.....	34	P01W (3646W).....	24
LF3/16K (PF223L).....	5	NH36LN (ART.1647) 5.4mm.....	29	P10 (36465-1/32).....	24
LF3/32.....	5	NH36LN-1(ART.1641) 5.4mm.....	34	P11 (36465-1/16).....	24
LF3/32K (PF221 1/2).....	5	NH36N (ART.1648) 5.4mm.....	30	P115 (36465-3/32).....	12
LF3/8.....	5	NH36N-1 (ART.1642) 5.4mm.....	34	P12 (36465-1/8).....	12
LF3/8K (PF226L).....	5	NH8310 (ART.1625/2-1/32)(NARROW)....	33	P127 (127233).....	17
LF-30-3.0mm.....	5	NH8311 (ART.1625/5-1/16).....	33	P127-NF (ART.6643).....	28
LF-40-4.0mm.....	5	NH8311N-1/16 (NARROW).....	33	P127WK-NF.....	28
LF5/16.....	5	NH8312 (ART.1625/6-1/8).....	33	P127W-NF (ART.6644).....	28
LF5/16K (PF225L).....	5	NH8313 (ART.1625/7-3/16).....	33	P13 (36465-3/16).....	12
LF5/32.....	5	NH8314 (ART.1625/8-1/4).....	33	P14 (36465-1/4).....	12
LF5/32K (PF222 1/2).....	5	NH8315 (ART.1625/9-5/6).....	33		
LF-50-5.0mm.....	5	NH8316 (ART.1625/10-3/8).....	33		

\* DK-DURKOPP \*NH-NECCHI

\* BROTHER \* JUKI \* PEGASUS \* SINGER

\*f

\* 'Majmasz

P144H (12144H).....	15	P3625-3/4 (S542-1").....	9	P69L1/8 (36069L1/8).....	8
P144HL (12144HLD).....	15	P363 (40322SH).....	13	P69L3/16 (36069L 3/16).....	8
P144HLB (12144HLB).....	15	P363-NF (S363NF)(ART.1680).....	27	P69L3/8 (36069L 3/8).....	8
P15 (36465-5/16).....	12	P363V (165010H).....	13	P69LH1/16 (L36069H1/16).....	8
P16 (36465-3/8).....	12	P363VNF.....	28	P69LH1/4 (L36069H1/4).....	8
P18 (36465-1/2).....	12	P363W-NF(ART.1688).....	27	P69LH1/8 (L36069H1/8).....	8
P193 (19336).....	16	P36D-NF (ART.6648).....	29	P69LH3/16 (L36069H3/16).....	8
P27 (S5050N)(149027)(149085).....	28	P36L (31358HW).....	14	P69LH-NF 1/4.....	25
P3 (165010).....	13	P36LN (31358HN).....	14	P69LH-NF 1/8.....	25
P301 (31358W).....	13	P36L-NF (S0080)(ART.1689).....	27	P69LH-NF 3/16.....	25
P301C1/4 (31358L 1/4).....	8	P36LN-NF (S0050N)(ART.1683).....	27	P69LH-NF 5/16.....	25
P301C1/8 (31358L 1/8).....	8	P36LW (31358HXW).....	14	P69R1/16 (36069R 1/16).....	8
P301C3/16 (31358L 3/16).....	8	P36N (12435HN).....	13	P69R1/2 (36069R 1/2).....	8
P301N (31358N).....	13	P36-NF (S8000N)(ART.1690).....	27	P69R1/4 (36069R 1/4).....	8
P31 (12435W).....	13	P36N-NF (S5000N)(ART.1684).....	27	P69R1/8 (36069R 1/8).....	8
P311 (12143).....	10	P36W (12435HXW).....	14	P69R3/16 (36069R 3/16).....	8
P311N (12435N).....	13	P375 (241375).....	43	P69R3/8 (36069R 3/8).....	8
P31C1/4 (12435R 1/4).....	8	P375BL.....	43	P69RH1/16(R36069H1/16).....	8
P31C1/8 (12435R 1/8).....	8	P37M-MED. GROVE.....	9	P69RH1/4 (R36069H1/4).....	8
P31C3/16 (12435R 3/16).....	8	P37-SMALL GROVE.....	9	P69RH1/8 (R36069H1/8).....	8
P33 (12142).....	10	P37W-LARGE GROVE.....	9	P69RH3/16 (R36069H3/16).....	8
P34.....	10	P3811-1/4 (S538-1/4).....	9	P69RH-NF 1/4.....	25
P344.....	10	P3819-1/2 (S539-1/2).....	9	P69RH-NF 1/8.....	25
P35 (24983).....	15	P3822-5/8 (5/8).....	9	P69RH-NF 3/16.....	25
P351 (52427).....	16	P3825-3/4 (S540-3/4").....	9	P69RH-NF 5/16.....	25
P351K.....	16	P39-PLAIN.....	9	P723 (S521)(3/16"~2").....	16
P351KS.....	3	P3C (40322).....	13	P723-NF 5mm~50mm.....	27
P351-NF 11mm(S351NF).....	28	P3CS (40322CS).....	13	P801 (1/32"~3/4").....	16
P351N-NF 9.0mm.....	27	P50 (120828).....	11	P803 (3/16"~7/8").....	16
P352.....	16	P50H (120828H).....	11	P81 (S523)(1/32"~3/4").....	16
P35G.....	24	P50M (120828M).....	11	P810 (12463H 1/32).....	7
P35G-NF.....	27	P50N (120828N).....	11	P810L (L12436H 1/32).....	7
P35K (24983K).....	15	P58N (142058N).....	15	P810-NF 1/32 1.0mm.....	25
P36 (12435HW).....	14	P58W (142058W).....	15	P811 (12463H 1/16).....	7
P360 (121947H).....	14	P5R (P5).....	12	P8115 (12463H 3/32).....	7
P360-NF (S2060N).....	27	P5W.....	12	P8115L (L12463H 3/32).....	7
P361 (121950H).....	14	P69D1/16 (36069DG 1/16).....	9	P811L (L12463H 1/16).....	7
P3610 15/64(5/8).....	9	P69D1/4 (36069DG 1/4).....	9	P811-NF 1/16 1.6mm.....	25
P3613-9/32 (S542-1/2).....	9	P69D1/8 (36069DG 1/8).....	9	P812 (12463H 1/8).....	7
P3619-1/2 (S542-3/4).....	9	P69D3/16 (36069DG 3/16).....	9	P812L (L12463H 1/8).....	7
P361-NF (S6020N).....	27	P69L1/16 (36069L 1/16).....	8	P812-NF 1/8 3.2mm.....	25
P3620 13/32 (13/16).....	9	P69L1/2 (36069L 1/2).....	8	P813 (12463H 3/16).....	7
P3622-5/8 (S542-7/8).....	9	P69L1/4 (36069L 1/4).....	8	P813L (L12463H 3/16).....	7

\* DK-DURKOPP \*NH-NECCHI

\*F

\* BROTHER \* JUKI \* PEGASUS \* SINGER

\*\*

*Majmasz*

P813-NF 3/16 4.8mm.....25	PFG264 (ART.1651/2-mm6.4-1.0mm).33	R-361-8mm (HM1-4).....20
P814 (12463H 1/4).....7	PFG248-1L (ART.1557/1 4.8mm-1.0mm).34	R-36-8mm (HM2-1).....20
P814L (L12463H 1/4).....7	PFG248-1R(ART.1695/1 4.8mm-1.0mm).34	R-36L-8mm (HM2-2).....20
P814-NF 1/4 6.4mm.....25	PFG248-2L (ART.1557/2 4.8mm-2.0mm).34	R-36LN-5mm (HM2-4).....20
P815 (12463H 5/16).....7	PFG248-2R(ART.1695/2 4.8mm-2.0mm).34	R-36LW-10mm .....20
P815L (L12463H 5/16).....7	PFG264 (ART.1651/2-mm6.4-2.0mm).33	R-36N-5mm (HM2-3).....20
P815-NF 5/16 8.0mm.....25	PFG264-1L (ART.1558/1 6.4mm-1.0mm).34	R-36W-10mm.....20
P816 (12463H 3/8).....7	PFG264-1R (ART.1696/1 6.4mm-1.0mm).34	R-3DWG 4.8mm (輪子三本用)..46
P816L (L12463H 3/8).....7	PFG264-2L (ART.1558/2 6.4mm-2.0mm).34	R-3DWG 5.6mm (輪子三本用)..46
P816-NF 3/8 9.6mm.....25	PFG264-2R(ART.1696/2 6.4mm-2.0mm).34	R-3DWG 6.4mm (輪子三本用)..46
P818 (12463H 1/2).....7	PFK-161-LIGHTEST(CFK-161).....6	R-3DW-G10 4.8mm (輪子三本用).....46
P818L (L12463H 1/2).....7	PFK-261-LIGHTEST W/TAIL(CFK-261).....6	R-3DW-G10 5.6mm (輪子三本用).....46
P820-NF 1/32 1.0mm.....25	PFR248 (ART.1628/1-mm4.8).....33	R-3DW-G10 6.4mm (輪子三本用).....46
P821-NF 1/16 1.6mm.....25	PFR264 (ART.1628/2-mm6.4).....33	R4-1 (HM6-1-2).....47
P822-NF 1/8 3.2mm.....25	R-1 (HM1-1)LIGHT.....33	R4-2 (HM6-1-4).....47
P823-NF 3/16 4.8mm.....25	R-1/16L.....20	R-457-1(17.5-7.5)(HM4-5) (輪子人字車)...41
P824-NF 1/4 6.4mm.....25	R-1/16LN.....20	R-457-2(20.5-10.5)(HM4-7)(輪子人字車)...41
P825-NF 5/16 8.0mm.....25	R-1/16R.....20	R-457-3(22.5-12.5)(輪子人字車).....41
P826-NF 3/8 9.6mm.....25	R-1/16RN (HM1/16).....20	R-457-4(24.5-14.5)(HM4-3)(輪子人字車)...41
P882 (229882).....43	R-1/32L.....20	R-5/16L.....20
P946 (121946).....25	R-1/32LN.....20	R-5/16R (HM5/16).....20
P983 (25983).....11	R-1/32R.....20	R-5/32R (HM5/32).....20
PF00 (CF00).....6	R-1/32RN (HM1/32).....20	R-5/64L.....20
PF10G-0~20mm(PFG10-CRL).....32	R-1/4L.....20	R-5/64R (HM5/64).....20
PF-131-HEAVY(CF-131-HEAVY)...6	R-1/4R (HM1/4).....20	R5-1X3mm (HM6-2-1X3mm).....47
PF-141-MEDIUM (CF-141-MEDIUM).6	R-1/8L.....20	R5-1X5mm (HM6-2-1X5mm).....47
PF-151-LIGHT (CF-151-LIGHT)...6	R-1/8R (HM1/8).....20	R5-2X3mm (HM6-2-2X3mm).....47
PF-231-HEAVY (CF-231-HEAVY)...6	R-2 (HM1-2)MEDIUM.....19	R5-2X5mm (HM6-2-2X5mm).....47
PF-241-MEDIUM (CF-241-MEDIUM).6	R-232-1/8" (輪子雙針用) HM7-1 1/8.....40	R-652-12mm(HM4-1).....31
PF248 (30715-3-00mm4.8).....33	R-248-3/16" (輪子雙針用) HM7-1 3/16.....40	R-652-6mm.....31
PF248-1 (ART.1694/1 4.8mm).....34	R-264-1/4" (輪子雙針用) HM7-1 1/4.....40	R-810 1/32.....19
PF-251-LIGHT (CF-251-LIGHT)..6	R-280-5/16" (輪子雙針用) HM7-1 5/16.....40	R-810L 1/32.....19
PF260 (961044-3-00mm6.0).....33	R-295-3/8" (輪子雙針用) HM7-1 3/8.....40	R-811 1/16 (HM3-1).....19
PF264 (961044-3-10mm6.4).....33	R2E.....19	R-811L 1/16.....19
PF264-1 (ART.1694/2 6.4mm).....34	R-3 (HM1-3)HEAVY.....19	R-812 1/8 (HM3-2).....19
PF518L (CF518L).....7	R-3/16L.....20	R-812L 1/8.....19
PF518N (CF518N).....7	R-3/16R (HM3/16).....20	R-813 3/16.....19
PF-A1L.....42	R-3/32L.....20	R-813L 3/16.....19
PF-A1R.....42	R-3/32R (HM3/32).....20	R-814 1/4.....19
PFD248 (ART.1639/1-mm4.8).....33	R3-1 (HM6-1-1).....47	R-814L 1/4.....19
PFD264 (ART.1639/2-mm6.4).....33	R3-2 (HM6-1-3).....47	R-815 5/16.....19
PFG248 (ART.1651/1-mm4.8-1.0mm).....33	R-351-NF-12mm(HM1-5).....27	R-815L 5/16.....19
PFG248 (ART.1651/1-mm4.8-2.0mm).....33	R-360-8mm.....20	RF1/16.....5

\* DK-DURKOPP \*NH-NECCHI

\* BROTHER \* JUKI \* PEGASUS \* SINGER

\*I *Majmasz*



RF1/16K (PF21 1R).....	5	S10C-1/8 (P318C1/8).....	12	S534 (A225).....	11
RF1/16N.....	5	S10C-3/16 (P3316C3/16).....	12	S536.....	20
RF1/16NK (PF211N).....	5	S10C-3/4 (P334C3/4).....	12	S541" (1-5/16").....	9
RF1/2.....	5	S10C-3/8 (P338C3/8).....	12	S543 (CHN).....	10
RF1/2K (PF218R).....	5	S10C-5/16 (P3516C5/16).....	12	S544 (CHW).....	10
RF1/32.....	5	S10C-5/8 (P358C5/8).....	12	S545 (P38).....	11
RF1/32K (PF21R).....	5	S10L-1" (P325L1").....	12	S570-A25 1/8 (5~50mm).....	39
RF1/32N.....	5	S10L-1/2 (P312L1/2).....	12	S570-A25 3/16(5~50mm).....	39
RF1/32NK (PF210).....	5	S10L-1/4 (P314L1/4).....	12	S570-A25 1/4 (5~50mm).....	39
RF1/4.....	5	S10L-1/8 (P318L1/8).....	12	S570-A25 5/16 (5~50mm).....	39
RF1/4K (PF214R).....	5	S10L-3/16 (P3316L3/16).....	12	S570GK-1/4 (可調式雙針靠檔).....	40
RF1/8.....	5	S10L-3/4 (P334L3/4).....	12	S570GK-1/8 (可調式雙針靠檔).....	40
RF1/8K (PF212R).....	5	S10L-3/8 (P338L3/8).....	12	S570GK-3/16 (可調式雙針靠檔).....	40
RF-100-10mm.....	5	S10L-5/16 (P3516L5/16).....	12	S570GK-3/8 (可調式雙針靠檔).....	40
RF-10-1.0mm.....	5	S10L-5/8 (P358L5/8).....	12	S570GK-5/16 (可調式雙針靠檔).....	40
RF-10N-1.0mm.....	5	S10R-1" (P325R1").....	12	S570S-1/2-1/16 (針距-邊距).....	38
RF-120-12mm.....	5	S10R-1/2 (P312R1/2).....	12	S570S-1/2-1/32 針距 邊距 ).....	38
RF-130-13mm.....	5	S10R-1/4 (P314R1/4).....	12	S570S-1/4-1/16 針距 邊距 ).....	38
RF-15-1.5mm.....	5	S10R-1/8 (P318R1/8).....	12	S570S-1/4-1/32 針距 邊距 ).....	38
RF-15N-1.5mm.....	5	S10R-3/16 (P3316R3/16).....	12	S570S-1/8-1/16 針距 邊距 ).....	38
RF-20-2.0mm.....	5	S10R-3/4 (P334R3/4).....	12	S570S-1/8-1/32 針距 邊距 ).....	38
RF-25-2.5mm.....	5	S10R-3/8 (P338R3/8).....	12	S570S-3/16-1/16 針距 邊距 ).....	38
RF3/16.....	5	S10R-5/16 (P3516R5/16).....	12	S570S-3/16-1/32 針距 邊距 ).....	38
RF3/16K (PF213R).....	5	S10R-5/8 (P358R5/8).....	12	S570S-3/8-1/16 針距 邊距 ).....	38
RF3/32.....	5	S457AT (503896)5~20mm.....	41	S570S-3/8-1/32 針距 邊距 ).....	38
RF3/32K (PF211 1/2).....	5	S457AT-G (503896-G)5~20mm.....	41	S570S-5/16-1/16 針距 邊距 ).....	38
RF3/8.....	5	S510.....	14	S570S-5/16-1/32 針距 邊距 ).....	38
RF3/8K (PF216R).....	5	S515 (CF2-S).....	18	S570SD-1/4-1/16 (針距-邊距).....	39
RF-30-3.0mm.....	5	S516 (CFR-S).....	18	S570SD-1/4-1/32 (針距-邊距).....	39
RF-40-4.0mm.....	5	S518-2.0mm.....	15	S570SD-1/8-1/16 (針距-邊距).....	39
RF5/16.....	5	S518A.....	15	S570SD-1/8-1/32 (針距-邊距).....	39
RF5/16K (PF215R).....	5	S518H-2.5mm.....	15	S570SD-3/16-1/16(針距-邊距).....	39
RF5/32.....	5	S518L.....	15	S570SD-3/16-1/32(針距-邊距).....	39
RF5/32K (PF212 1/2).....	5	S518N.....	15	S570SL-1/2-1/16 針距 邊距 ).....	38
RF-50-5.0mm.....	5	S518NE.....	15	S570SL-1/2-1/32 針距 邊距 ).....	38
RF-60-6.0mm.....	5	S518-NF (ART.1525/1).....	29	S570SL-1/4-1/16 針距 邊距 ).....	38
RF-65-6.5mm.....	5	S518N-G.....	15	S570SL-1/4-1/32 針距 邊距 ).....	38
RF-70-7.0mm.....	5	S518N-NF (ART.1526/1).....	28	S570SL-1/8-1/16 針距 邊距 ).....	38
RF-80-8.0mm.....	5	S518S.....	15	S570SL-1/8-1/32 針距 邊距 ).....	38
RF-90-9.0mm.....	5	S524 (7/32"~1").....	16	S570SL-3/16-1/16 針距 邊距 ).....	38
S10C-1" (P325C1").....	12	S530S.....	13	S570SL-3/16-1/32 針距 邊距 ).....	38
S10C-1/2 (P312C1/2).....	12	S531L.....	13	S570SL-3/8-1/16 針距 邊距 ).....	38
S10C-1/4 (P314C1/4).....	12	S532 (P312SB).....	11	S570SL-3/8-1/32 針距 邊距 ).....	38

\* DK-DURKOPP \*NH-NECCHI

\* BROTHER \* JUKI \* PEGASUS \* SINGER

\*f

\*' *Majmasz*

S570SL-5/16-1/16(針距邊距).....	38	SP-44.....	17	TCL1/4B (MT224B).....	22
S570SL-5/16-1/32(針距邊距).....	38	SP-60 (S402).....	17	TCL1/8 (MT222).....	22
S70F-1/16.....	9	SP-61 (S801).....	17	TCL1/8B (MT222B).....	22
S70F-1/2.....	9	SP-62 (S802).....	17	TCL3/16 (MT223).....	22
S70F-1/4.....	9	SP-63 (S803).....	17	TCL3/16B (MT223B).....	22
S70F-1/8.....	9	SP-64 (S804).....	17	TCL3/32 (MT221 1/2).....	22
S70F-3/16.....	9	SP-65 (S400).....	17	TCL3/32B (MT221 1/2B).....	22
S70F-3/8.....	9	SPK-3.....	19	TCL3/8 (MT226).....	22
S70F-5/16.....	9	SR-1.....	10	TCL3/8B (MT226B).....	22
S950 (P950).....	12	SR-DB-H (尼龍帶) (TRF-1-R).....	18	TCL5/16 (MT225).....	22
S952 (P952).....	12	SR-DB-L.....	18	TCL5/16B (MT225B).....	22
SDRF.....	19	SR-DB-R.....	18	TCR1/16 (MT211).....	22
SP18-1/16 1.6mm.....	4	SR-DB-W (TRF-1).....	18	TCR1/16B (MT211B).....	22
SP18-1/32 1.0mm.....	4	T35 1mm.....	23	TCR1/16N (MT211N).....	22
SP18-1/4 6.4mm.....	4	T350 11mm.....	23	TCR1/16NB (MT211NB).....	22
SP18-1/8 3.2mm.....	4	T350B 11mm.....	23	TCR1/2 (MT218).....	22
SP18-3/16 4.8mm.....	4	T35B 11mm.....	23	TCR1/2B (MT218B).....	22
SP18-3/32 2.4mm.....	4	T35C 11mm.....	23	TCR1/32 (MT21R).....	22
SP18-3/8 9.6mm.....	4	T35CB 11mm.....	23	TCR1/32B (MT21RB).....	22
SP18-5/16 8.0mm.....	4	T35CW 12.7mm.....	23	TCR1/32N (MT210).....	22
SP18L-1/16 1.6mm.....	4	T35CWB 12.7mm.....	23	TCR1/32NB (MT210B).....	22
SP18L-1/32 1.0mm.....	4	T35W 12.7mm.....	23	TCR1/4 (MT214).....	22
SP18L-1/4 6.4mm.....	4	T35WB 12.7mm.....	23	TCR1/4B (MT214B).....	22
SP18L-1/8 3.2mm.....	4	T36 10.5mm.....	23	TCR1/8 (MT212).....	22
SP18L-3/16 4.8mm.....	4	T363 6mm.....	23	TCR1/8B (MT212B).....	22
SP18L-3/32 2.4mm.....	4	T363B 6mm.....	23	TCR3/16 (MT213).....	22
SP18L-3/8 9.6mm.....	4	T36B 10.5mm.....	23	TCR3/16B (MT213B).....	22
SP18L-5/16 8.0mm.....	4	T36L 10.5mm.....	23	TCR3/32 (MT211 1/2).....	22
SP18L-NF 1/16 1.6mm.....	25	T36LB 10.5mm.....	23	TCR3/32B (MT211 1/2B).....	22
SP18L-NF 1/32 1.0mm.....	25	T36LN 6mm.....	23	TCR3/8 (MT216).....	22
SP18L-NF 1/4 6.4mm.....	25	T36LNB 6mm.....	23	TCR3/8B (MT216B).....	22
SP18L-NF 1/8 3.2mm.....	25	T36N 6mm.....	23	TCR5/16 (MT215).....	22
SP18L-NF 3/16 4.8mm.....	25	T36NB 6mm.....	23	TCR5/16B (MT215B).....	22
SP18L-NF 3/32 2.4mm.....	25	TCL1/16 (MT221).....	22	US12435HN.....	21
SP18L-NF 3/8 9.6mm.....	25	TCL1/16B (MT221B).....	22	US12435HW.....	21
SP18L-NF 5/16 8.0mm.....	25	TCL1/16N (MT221N).....	22	US31-1/32.....	21
SP18-NF 1/16 1.6mm.....	25	TCL1/16NB (MT221NB).....	22	US311-1/16.....	21
SP18-NF 3/32 2.4mm.....	25	TCL1/2 (MT228).....	22	US312-1/8.....	21
SP18-NF 1/32 1.0mm.....	25	TCL1/2B (MT228B).....	22	US313-3/16.....	21
SP18-NF 1/4 6.4mm.....	25	TCL1/32 (MT22).....	22	US31358HN.....	21
SP18-NF 1/8 3.2mm.....	25	TCL1/32B (MT22B).....	22	US31358HW.....	21
SP18-NF 3/16 4.8mm.....	25	TCL1/32N (MT220).....	22	US314-1/4.....	21
SP18-NF 3/8 9.6mm.....	25	TCL1/32NB (MT220B).....	22	US40322SH.....	21
SP18-NF 5/16 8.0mm.....	25	TCL1/4 (MT224).....	22	YS-37 (NP-37).....	22

\* DK-DURKOPP \* NH-NECCHI \* I

\* BROTHER \* JUKI \* PEGASUS \* SINGER \*

*Majmasz*